



Operating and installation instructions Commercial washing machine

PW 6163

PW 6243

PW 6323

To avoid the risk of accidents or damage to the machine, it is **essential** to read these instructions before it is installed and used for the first time.

en-GB

Contents

Warning and Safety instructions	5
Explanation of the safety instructions and warnings on the machine.....	5
Intended use.....	6
Foreseeable misuse.....	7
Technical safety.....	9
Correct use.....	11
Chlorine and component damage.....	13
Accessories.....	14
Disposing of your old machine.....	14
Caring for the environment	15
Description of the machine	17
Machine description.....	17
Control elements – unclean side (infeed side).....	18
Control elements – clean side (outfeed side, full version).....	19
Control elements – clean side (outfeed side without display).....	19
Function buttons	20
Programme card for the supervisor.....	21
Initial commissioning	22
Washing	23
Preparing the laundry	23
Emptying pockets	23
Maximum load size.....	23
Switching on the washing machine.....	23
Loading the washing machine.....	24
Opening the hinged door	24
Opening the drum	24
Loading the laundry.....	25
Closing the drum.....	25
Closing the hinged door	26
Adding detergent.....	27
Bleaching agents.....	28
Detergent dispensing	28
Selecting a programme	30
Additional functions.....	31
Selecting a Pre-wash	31
Starching the laundry	31
Deactivating the spin cycle	31
Setting a start time	31
Temporarily changing the language	34
Programme modifications	35
Changing the load size.....	35
Changing the temperature.....	35
Altering the spin speed.....	35
Starting the programme	36
Displaying additional programme information	36

End of the programme	37
End of programme (removal on unclean side).....	37
End of programme (removal on clean side).....	37
End of programme (clean side without display)	37
Opening the hinged door at the end of the programme	37
Opening the drum	37
Removing the laundry and closing the drum	38
Closing the hinged door	39
Moving the drum door to the clean side	39
Finishing cancelled programmes	39
Switching off the washing machine	40
Washing by card operation	41
Washing with a programme card	41
Fixing card errors	42
Laundry load operation	42
Additional functions	43
Temporarily changing the language	43
Start time.....	44
Cancelling the start time	44
With pre-wash	45
Without spin	46
Programme stop.....	46
Programme cancellation.....	47
Cancelling a locked programme.....	47
Skipping a programme	48
Optional modules	49
Liquid dispensing (optional for machines with dispenser compartment).....	49
Deselecting dispensing	49
Amount to be dispensed	50
Commissioning the dispensing pumps	50
Dispenser calibration.....	50
Cleaning and maintenance of the dispensing system.....	52
Peak-load negotiation	52
Communication module	52
Operating data.....	52
Total data.....	53
Programme data.....	54
Delete data	55
Weighing system/weighing plinth.....	56
Resetting the load display to zero	56
Sampling tap	58
Problem solving guide	60
Troubleshooting.....	60
Fault messages in the display	63
Contact in case of malfunction	65
Cleaning and care	66
Cleaning the casing and fascia panel	66
Cleaning the detergent drawer, detergent compartments and siphons.....	66

Contents

Cleaning the ventilation grilles.....	67
Checking the closing device	68
Treating rust.....	68
Drum shaft bearings	69
Meaning of the symbols on the data plate	70
Airborne noise emission	71
Installation	72
Installing the washing machine	72
General operating conditions	72
Do not install in rooms which may be subject to very low temperatures.....	72
Installing and mounting the washing machine	72
Removing the transit bars	74
Transporting the washing machine	74
Removing the transit bars on the weighing system	75
Water connection	76
Use of non-return valves	77
Regulations for Austria	77
Detergent connections	77
Electrical connection	79
Equipotential bonding	80
Connecting the dispensing pumps	81
Steam connection	81
Quick Start Guide	82

Explanation of the safety instructions and warnings on the machine



Read the operating instructions



Read all the instructions, e.g. the installation instructions



Warning, hot surfaces



Warning, voltage up to 1000 volts



Earthing



Equipotential bonding

This washing machine complies with all current local and national safety requirements. However, inappropriate use can lead to personal injury and damage to property.

Read the operating instructions carefully before using the washing machine. They contain important information on safety, installation, use and maintenance. This prevents both personal injury and damage to the washing machine.

In accordance with standard IEC 60335-1, Miele expressly and strongly advises that you read and follow the instructions in the chapter on installing the washing machine as well as the safety instructions and warnings.

Miele cannot be held liable for damage caused by non-compliance with these instructions.

Keep these operating instructions in a safe place and pass them on to any future owner.

When instructing other people how to use the washing machine, they must be made aware of these safety and warning instructions.

Warning and Safety instructions

Intended use

- ▶ The washing machine is only suitable for washing fabrics with a care label stating that they are suitable for machine washing. Any other applications may be dangerous. The manufacturer cannot be held liable for damage resulting from incorrect or improper use or operation of the machine.
- ▶ This washing machine must be used as described in the operating instructions and must be checked on a regular basis to make sure it is functioning correctly. Maintenance must be carried out when necessary.
- ▶ The washing machine is not suitable for outdoor use.
- ▶ Do not install your washing machine in a room where temperatures below freezing may occur. Frozen hoses are at risk of tearing or bursting. The reliability of the electronic module may be impaired at temperatures below freezing point.
- ▶ This washing machine is intended only for use in a commercial environment.
- ▶ The washing machine must not be used in a non-stationary installation site (e.g. on a ship).
- ▶ This washing machine is only intended for items of laundry which have not been impregnated with dangerous or inflammable substances.
- ▶ For disinfection procedures, use temperatures, holding times, liquor ratios and, if necessary, disinfectants to achieve the required infection prophylaxis in accordance with guidelines and microbiological and hygienic standards.
- ▶ Disinfection programmes must not be interrupted, as this can have a limiting effect on the disinfection result. It is the operator's responsibility to ensure that the standard of disinfection in thermal as well as chemo thermal procedures is maintained by carrying out suitable validation tests.
- ▶ If the laundry has special result quality requirements, such as rinsing result, an absence of particles, wettability and liquid permeability, the procedure must be validated accordingly. The supervisor must guarantee the reprocessing standard with regular quality checks.
- ▶ Do not store or use petrol, paraffin or any easily flammable substances near the washing machine. There is a risk of fire and explosion.
- ▶ If the washing machine is operated in a publicly accessible place, it is the supervisor's responsibility to ensure that suitable measures are in place to protect users from any source of risk or danger.

Warning and Safety instructions

- ▶ This washing machine can only be used by people with reduced physical, sensory or mental capabilities, or lack of experience or knowledge, if they are supervised whilst using it or have been shown how to use it in a safe way and understand and recognise the consequences of incorrect operation.
- ▶ Children under the age of 8 must not be allowed near the washing machine unless they are constantly supervised.
- ▶ Children over the age of 8 may only use the washing machine without supervision if its operation has been clearly explained to them and they are able to use it safely. Children must be able to understand and recognise the possible dangers caused by incorrect operation.
- ▶ Children may not carry out cleaning or maintenance on the washing machine unsupervised.
- ▶ Always supervise any children in the vicinity of the washing machine. Never allow children to play with the washing machine.
- ▶ Any uses other than those listed above are prohibited. The manufacturer accepts no liability in such cases.

Foreseeable misuse

- ▶ Never use solvent based cleaning agents, e.g. those containing benzene, in this washing machine. Doing so may result in damage to component parts and create toxic steam and fumes. **Risk of fire and explosion!**
- ▶ When washing with high temperatures, remember that the porthole glass becomes hot. Do not let children touch it during a wash programme.

Danger of burning!

- ▶ Close the drum door after each wash cycle. This will prevent:
 - Children climbing into the washing machine or hiding things in it.
 - Pets or other small animals climbing into the washing machine.
- ▶ Do not damage, remove or bypass the safety components or control elements of this washing machine.
- ▶ Machines with a damaged control panel, wires or cables must not be used until they have been repaired.
- ▶ The water generated during washing is suds and not drinking water. Drain the suds into a proper drainage system.
- ▶ Always make sure that the drum is stationary before reaching in to remove laundry. Reaching into a moving drum is extremely dangerous. Danger of injury.
- ▶ Be careful not to put your hands in the gap between door and frame when closing the drum door.

Warning and Safety instructions

▶ If the detergent compartment drawer is open and any of the dispenser drawers are missing, there is a **danger of scalding from splashing water**.

Do not operate the machine if any of its components are missing.

▶ It is particularly important to observe manufacturer's instructions when using a combination of cleaning agents and special application products. Products must only be used for applications approved by the manufacturer to avoid any material damage or the occurrence of strong chemical reactions.

Technical safety

- ▶ This washing machine must be installed by the Miele Customer Service Department or by an authorised dealer.
- ▶ Before setting up the washing machine, check it for any externally visible damage. Do not install or use a damaged washing machine.
- ▶ The electrical safety of this washing machine can only be guaranteed when correctly earthed. It is most important that this basic safety requirement is regularly tested, and where there is any doubt the on-site wiring system should be inspected by a qualified electrician. Miele cannot be held liable for the consequences of an inadequate earthing system (e.g. electric shock).
- ▶ Unauthorised repairs could result in unforeseen dangers for the user, for which the manufacturer cannot accept liability. Repairs should only be undertaken by a Miele approved service technician, otherwise any subsequent damage will not be covered by the guarantee.
- ▶ Do not make any alterations to the machine, unless authorised to do so by Miele.
- ▶ Disconnect the washing machine from the power supply in the event of a fault and for cleaning and maintenance. The washing machine is only electrically disconnected from the power supply when:
 - The plug of the washing machine is unplugged, or
 - The mains fuse is disconnected, or
 - The screw-in fuse has been completely removedSee also “Installation – Electrical connection”.
- ▶ Washing machines with a damaged control element or cable insulation must not be used until they have been repaired.
- ▶ Only operate the washing machine when all removable outer panels are in place so that it is impossible to touch an electrical component or moving part.
- ▶ In the event of a fault or for cleaning and maintenance purposes, the washing machine must be isolated from the electricity supply. It is only completely isolated when:
 - The plug of the washing machine is unplugged, or
 - The mains fuse is disconnected, or
 - The screw-in fuse has been completely removed
- ▶ See also “Installation – Electrical connection”.
- ▶ The plug for the washing machine must always be kept accessible so that the machine can be easily disconnected from the power supply.

Warning and Safety instructions

- ▶ The washing machine may only be connected to the water supply using the set of hoses supplied with the machine. Old sets of hoses must not be re-used. Check the sets of hoses regularly for signs of wear. Change the sets of hoses in good time to avoid the risk of leaks and subsequent water damage.
- ▶ Faulty components must only be replaced by genuine Miele spare parts. Miele can only guarantee the safety standards of the appliance when Miele spare parts are used.
- ▶ The cause of any leaks must be dealt with before the washing machine is restarted. Disconnect the washing machine immediately if any water leaks out.
- ▶ Steam heating malfunctions can result in high temperatures at the door, the dispenser and inside the drum (in particular at the edge of the drum). There is a risk of slight burns.
This only applies to machines with steam heating.
- ▶ All relevant national provisions and regulations (DGUV in Germany) relating to accident insurance are applicable to this machine. It is recommended to carry out testing in accordance with the regulatory framework described in DGUV100-500 /Chapter 2.6/ Section 4. The test book required for the documentation is available from Miele.
- ▶ Follow the instructions in “Installation”.
- ▶ If the machine is to be hard-wired, there must be a means of disconnecting all poles from the power supply. The mains switch must be close to the washing machine and be clearly identifiable, un-hindered and easily accessible at all times.
- ▶ If the machine’s mains connection cable has been damaged, it must be replaced by the manufacturer or a qualified specialist.
- ▶ The power supply must be disconnected when performing maintenance or replacing parts on the machine. If the plug needs to be disconnected from the socket, the operating personnel must ensure that the plug remains disconnected at all times.

Correct use

- ▶ The maximum dry laundry weight is
 - for PW 6163: 16 kg
 - for PW 6243: 24 kg
 - for PW 6323: 32 kg

See the “Programme chart” for the maximum recommended load sizes for individual programmes.

- ▶ Before using the washing machine for the first time, check that the transport safety devices have been removed (see “Installation – Removing the Transport safety devices”). During spinning, transport safety devices which are still in place may result in damage to both the washing machine and adjacent furniture or machines.
- ▶ Never try to open the drum door of the washing machine using force. The door can only be opened when a corresponding message appears in the display.
- ▶ When washing with high temperatures, remember that the porthole glass and drum door become hot. You must therefore keep children away from the porthole glass and drum door during the wash cycle.
- ▶ Close the drum door after each wash cycle. This will prevent:
 - Children climbing into the washing machine or hiding things in it.
 - Pets or other small animals climbing into the washing machine.
- ▶ Always close the drum door carefully. There is a risk of crushing and injury by shearing in the area around the hinges of the drum door.
- ▶ It must be possible to open the drum door fully. There must be no doors or other structural elements in the vicinity which prevent the drum door from opening.
- ▶ Always make sure that the drum is stationary before reaching in to remove laundry. Touching a moving drum poses a significant risk of injury.
- ▶ The procedures and machines listed here are not medical devices. Observe the programme descriptions and procedural information in the programme chart.
- ▶ Laundry is only disinfected in programmes with a disinfection step. All other programmes do not have a disinfection step (see the “Hygiene” programme chart). If laundry that has not been disinfected is transferred to the “clean” side of the washing machine, germ transfer or contamination may occur. The transfer of non-disinfected laundry to the “clean” side is the sole responsibility of the supervisor.
- ▶ This washing machine may only be operated without supervision if there is a floor drain (gully) in the direct vicinity of the washing machine.

Warning and Safety instructions

▶ Disinfectants and detergents often contain chlorine-containing compounds. When agents containing chlorine dry on stainless steel surfaces, the resulting chlorides can attack the stainless steel and produce rust. Protect your washing machine from rust damage by using chlorine-free agents to wash, disinfect and clean the stainless steel surface. If in doubt, have the manufacturer confirm the suitability of the agent.

If agents containing chlorine get onto the stainless steel surface, clean the stainless steel surface immediately with water. Then use a cloth to dry the stainless steel surface.

▶ It is particularly important to observe manufacturer's instructions when using a combination of cleaning agents and special application products. Agents must only be used for applications approved by the manufacturer to avoid any material damage or the occurrence of strong chemical reactions. Confirmation must be sought from the manufacturer that using the agent in the washing machine will not cause damage.

▶ If the correct amount of detergent is dispensed, the machine should not need to be descaled. If, however, you do wish to descale it, only use proprietary non-corrosive descaling agents and strictly observe the instructions on the packaging. Special descaling agent is available from Miele. Strictly observe the instructions for the descaling agent.

▶ Close the stopcock if the machine is to be left for any length of time (e.g. while on holiday), especially if there is no floor drain (gully) in the immediate vicinity.

▶ Take care to ensure that foreign objects (e.g. nails, pins, coins, paper clips) do not find their way into the machine with the laundry. Foreign objects may damage components of the machine (e.g. suds container, drum). Damaged components can damage the laundry.

▶ Textiles which have been pre-treated in solvent-based cleaning agents must be rinsed in clean water before being washed in the machine. Note that solvent residues may only be discharged into waste water in compliance with local legislation.

▶ Never use solvent based cleaning agents, e.g. those containing benzene in this machine. Doing so may result in damage to component parts and create toxic fumes. **Risk of fire and explosion!**

▶ Do not store chemicals (liquid detergents, additives) on the machine lid. They may cause discolouration or lacquer damage. Accidentally spilled chemicals should be removed immediately with a wet cloth from the surface.

▶ There is a fan outlet on the back of the machine. Under no circumstances must this be blocked. Please observe the minimum distance on the installation diagram.

Warning and Safety instructions

- ▶ Recommending chemical cleaning agents does not mean that the machine manufacturer is responsible for the influences of these agents on the laundry and the washing machine. Please note that undisclosed product changes by the manufacturers of these agents may affect the quality of the wash result.
- ▶ Only use dyes, dye removers and descalers suitable for use in a washing machine. The manufacturer's instructions on the packaging must be observed.
- ▶ Colour run and dye removers contain sulphur compounds which can cause damage such as corrosion. Do not use these products in this machine.
- ▶ Check the wash result of laundry contaminated with biological oils or greases. Inadequately washed laundry can cause spontaneous combustion during the drying process. Use special detergents or wash programmes for this kind of laundry.
- ▶ Do not use a pressure washer or hose to clean the washing machine.

Chlorine and component damage

- ▶ Frequent use of chlorine products increases the risk of damage to components.
- ▶ The use of substances containing chlorine, such as sodium hypochlorite and chlorine bleach in powder form, can however result in damage of the protective layer of stainless steel and corrosion on components. Therefore, refrain from using substances containing chlorine. Use oxygen-based bleaching agents instead.

If, however, chlorine bleaching agents are used, an anti-chlorine treatment must always be carried out. Otherwise, both the washing machine components and the laundry may suffer persistent and irreparable damage.

- ▶ Anti-chlorine treatment must be carried out immediately after chlorine bleaching agents have been used. Hydrogen peroxide as well as oxygen-based detergents and bleaching agents are suitable for anti-chlorine treatment. The suds must not be drained in between.

Treatments with thiosulphates can result in gypsum-like deposits particularly when used in combination with hard water. This gypsum can build up in the washing machine or cause incrustations on the laundry. Treatment with hydrogen peroxide is recommended over treatment with thiosulphates because hydrogen peroxide neutralises chlorine.

The exact dispensing quantities and the treatment temperatures required must be set and tested on site in accordance with the dispensing recommendations of the detergent and cleaning agent manufacturers. The laundry must also be tested to check whether it contains any active chlorine residues.

Warning and Safety instructions

Accessories

▶ Accessory parts may only be fitted when expressly approved by Miele. If other parts are used, guarantee, performance and product liability claims will be invalidated.

Miele cannot be held liable for damage caused by non-compliance with these Warning and Safety instructions.

Disposing of your old machine

▶ Ensure that the door locks are unusable when disposing of or scrapping old washing machines. This will prevent the risk of children playing accidentally locking themselves in and endangering their lives.

Disposal of the packing material

The packaging is designed to protect against transportation damage. The packaging materials used are selected from materials which are environmentally friendly for disposal and should be recycled.

Recycling the packaging reduces the use of raw materials in the manufacturing process and also reduces the amount of waste in landfill sites. Your dealer will take the packaging materials away.

Disposing of your old appliance

Electrical and electronic appliances often contain valuable materials. They also contain specific materials, compounds and components, which were essential for their correct function and safety. These could be hazardous to human health and to the environment if disposed of with your domestic waste or if handled incorrectly. Please do not, therefore, dispose of your old appliance with your household waste.

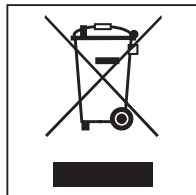

Please dispose of it at your local community waste collection / recycling centre for electrical and electronic appliances, or contact your dealer or Miele for advice. You are also responsible (by law, depending on country) for deleting any personal data that may be stored on the appliance being disposed of. Please ensure that your old appliance poses no risk to children while being stored prior to disposal.

Caring for the environment

Energy saving tips

- Energy and water consumption** - To get the most out of your machine, load the **maximum** dry load size for the wash programme you are using.
Energy and water consumption is most efficient when a full load is washed.
- Detergent**
- Do not exceed the amounts of detergent recommended by the manufacturer on the packaging.
 - Reduce the amount of detergent for smaller load sizes.
- When drying with a tumble dryer** Select the highest possible spin speed for the wash programme to save energy in the subsequent tumble dryer cycle.

Machine description

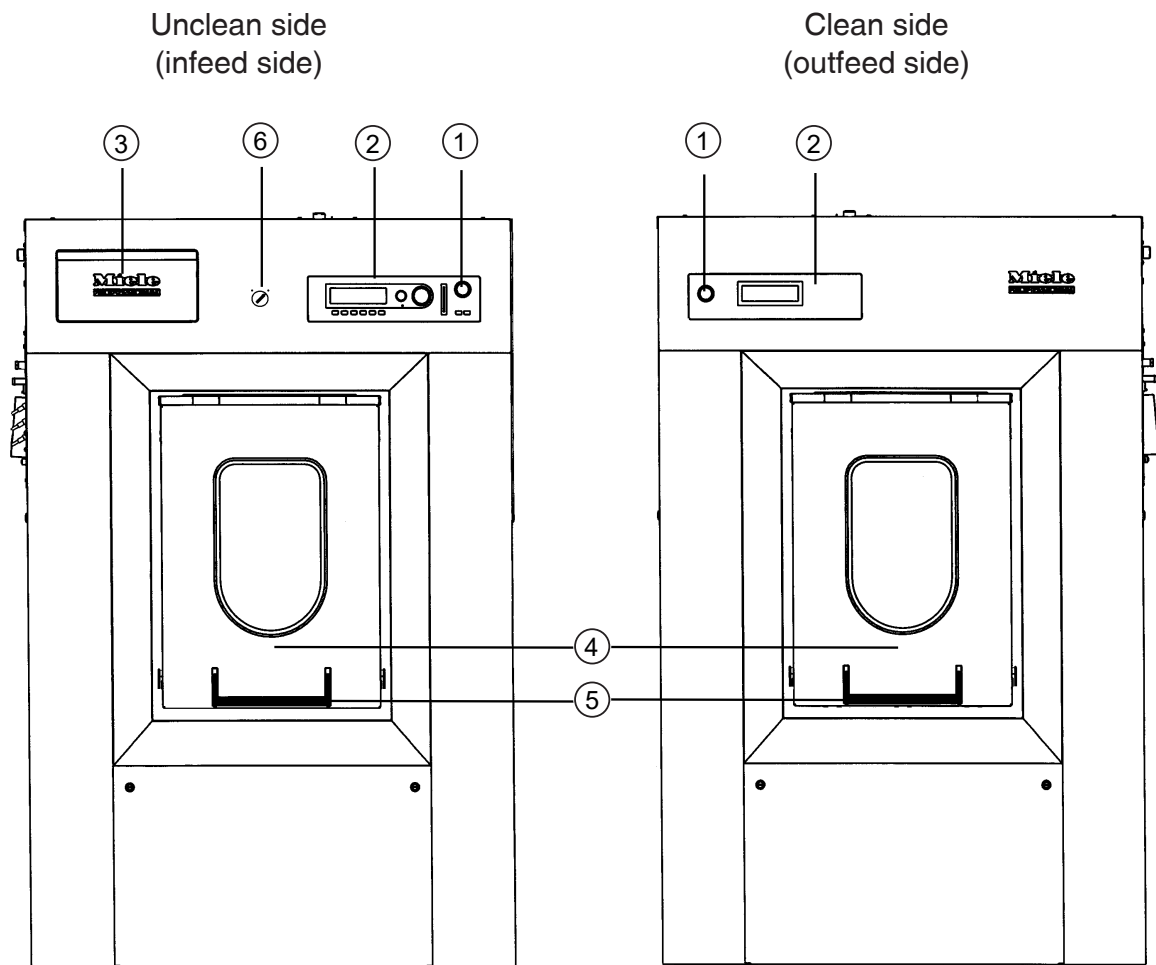

① **Emergency shut-off**

Pressing the red button switches the machine off in an emergency.

② **Control panel**

③ **Detergent drawer**

④ **Hinged door**

The hinged door is opened by pulling up the door handle and closed by pushing down the door handle. Never use force to open the hinged door.

⑤ **Door handle**

The door handle is equipped with a safety catch. When the wash programme is running and the door lock is locked, the door handle can be pulled up, but the hinged door remains locked. Push the door handle down again and wait for the end of the programme. Then open the hinged door.

Description of the machine

⑥ Selector switch for heating type (depending on model)

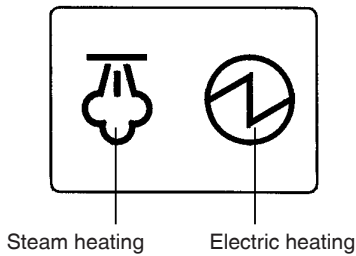

The switch can be used to change between the “steam heating” and “electric heating” heating types.

Control elements – unclean side (infeed side)

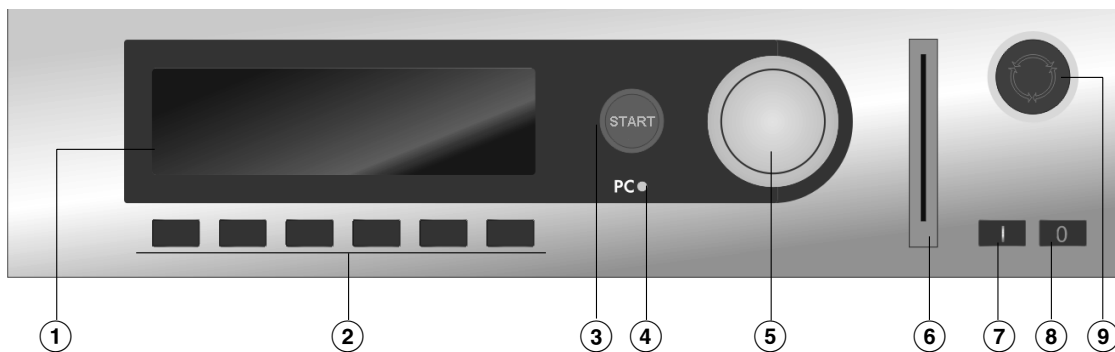

① Display

② Function buttons

These buttons are allocated specific functions depending on the washing machine status. The current function of the buttons is indicated by the symbols in the display. If a function has been selected using the buttons, the corresponding symbol remains highlighted in the display.

By reprogramming “Direct button allocation”, the first 6 programmes in the programme list can be selected using buttons 1–6.

③ Start button

The light ring around the button flashes when a selected programme is ready to start. The selected programme starts when the **start** button is pressed.

If the **start** button is pressed once the programme has started, the display content is shown as before.

④ PC optical interface

Using PC software, data can be transmitted to and from the controls to a PC. The connection is made via the optical interface of the control panel.

⑤ Rotary control

Display selection fields and input fields can be selected by turning the rotary control. Pressing the rotary control allows changes to be made to the display selection fields or input fields and also confirms these changes.

⑥ Card reader

When a programme card is inserted into the card reader, the programmes saved on the card can be used. Always insert the programme card in the direction of the arrow.

- ⑦ **1** button
For switching on the washing machine
- ⑧ **0** button
For switching off the washing machine
- ⑨ Emergency shut-off
Only press in case of danger. Pressing the red emergency-stop button switches the machine off. Once the danger has been averted, the button can be unlocked by turning it clockwise.

Control elements – clean side (outfeed side, full version)

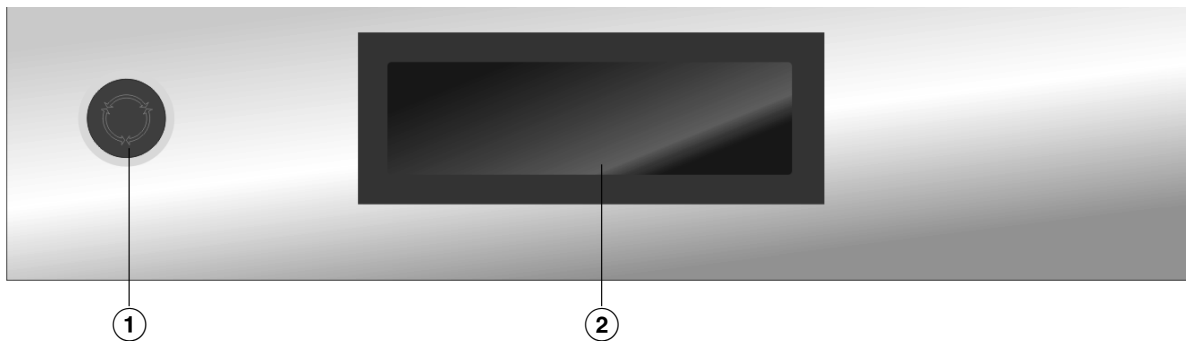

- ① **Emergency shut-off**
- ② **Display**

Control elements – clean side (outfeed side without display)

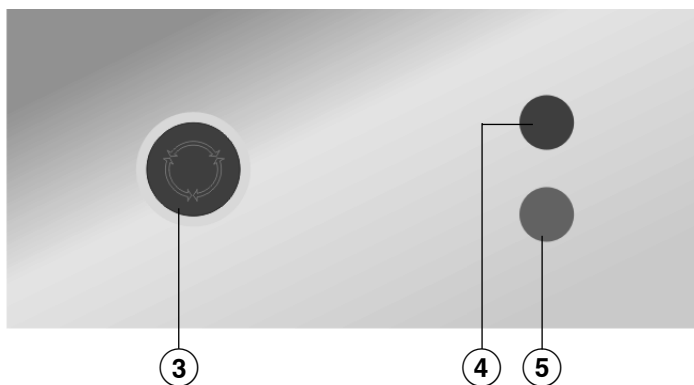

- ③ **Emergency shut-off**
- ④ **Red “programme stop” indicator light**
Lights up in the event of a programme stop or a programme stop caused by a fault or when peak-load control is active.
- ⑤ **Green “end of programme” indicator light**

Description of the machine

Function buttons

Pressing the button activates the function and pressing it again deselects the function.

Stop/finish

The right-hand function button is used as the finish button after a programme has started. Pressing it stops the selected programme or finishes a stopped programme.

Block+

The corresponding programme block (e.g. Pre-wash) is added to the programme.

Starch stop

Pressing this button starches the laundry.

Without spin

Press this button if you do not want the machine to spin automatically after rinsing.

Change language

Another language can be temporarily selected by pressing this button.

Start date and time

A later programme start time can be selected by pressing this button before starting a programme.

Info

If information (e.g. the telephone number of the Miele Customer Service Department) has been stored during commissioning, this information is shown in the display by pressing this button.

Water drainage

Manual control

Wash functions can be executed manually by pressing this button without having to start a programme.

Skip

Pressing this button allows the programme running time of the current wash programme to be shortened or a programme block to be repeated.

Back

Press this button to return to the previous display menu.

Information on next/previous line

Save

Pressing this button saves a setting that has been made.

Programme locked

Pressing the  button prevents a locked programme from being stopped or cancelled after a programme running time of 1 minute.

Programme unlocked

Pressing this button unlocks a locked programme.

Dispensing

Dispensing switched off

Operating data

Tare

Press this button to set the weight on the scale of the weighing system to zero. Use this button when the load indicator is not 00.0 when the drum is empty.

Programme card for the supervisor

There are no programmes on this card ex works. Please refer to the programming instructions for information on how data is transferred from the controls to the card.

If a card with saved programmes is placed in the card reader before the programme is started, the controls no longer access the internal programme memory. The content of the card is read and shown in the display as a programme list with the indication Card operation.

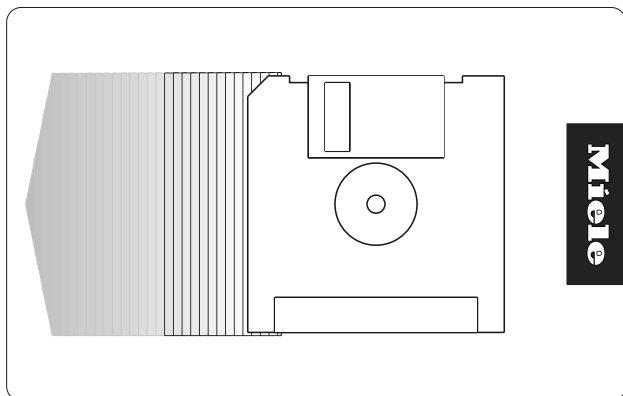

The card can hold a maximum of 30 programmes consisting of 6 blocks each. The back of the card can be labelled.

Initial commissioning

 Damage resulting from incorrect installation and connection. Installing and connecting the washing machine incorrectly will cause serious material damage.

The washing machine must be installed by Miele Customer Service Department or by an authorised dealer.

Follow the instructions in “Installation”.

The washing machine must be commissioned by the Miele Customer Service Department or by an authorised dealer.

Preparing the laundry

Emptying pockets

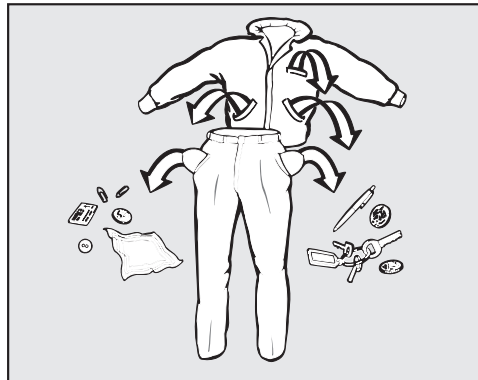

- Empty all pockets.

⚠ Damage due to foreign objects.

Nails, coins, paper clips, and so on can cause damage to garments and components in the machine.

Check the laundry before washing and remove any foreign objects.

Maximum load size

Observe the maximum load size (dry weight) for your washing machine. The most efficient use of energy and water is achieved when a full load is washed. However, do not overload as this makes cleaning less effective and causes creases.

PW 6163	PW 6243	PW 6323
≤ 16 kg	≤ 24 kg	≤ 32 kg

Switching on the washing machine

- Open the on-site shut-off valves for water and, depending on the heating type, for steam.
- Switch on the on-site mains switch.
- Press the **1** button.



The welcome screen will appear in the display.

The programme list is then displayed. The last started programme is highlighted.

Washing

Loading the washing machine

Opening the hinged door

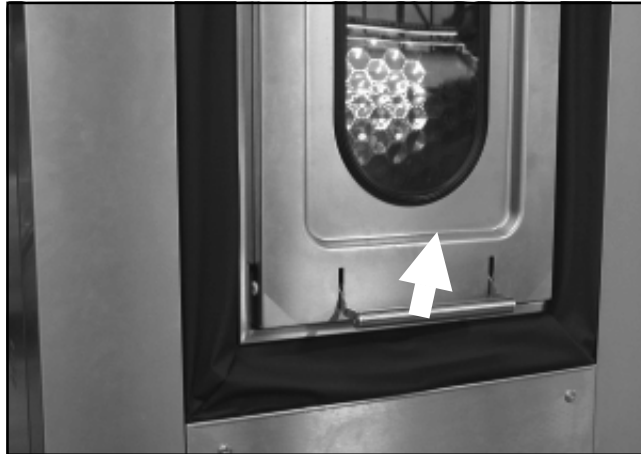

- Pull the door handle upwards on the unclean side of the washing machine (infeed side).
- Pull the hinged door upwards.

The gas pressure stays push the hinged door up.

Opening the drum



- Press the locking mechanism with your thumb.
- Press the two halves of the drum door simultaneously until they are unlocked.
- Open the two halves of the drum door outwards.

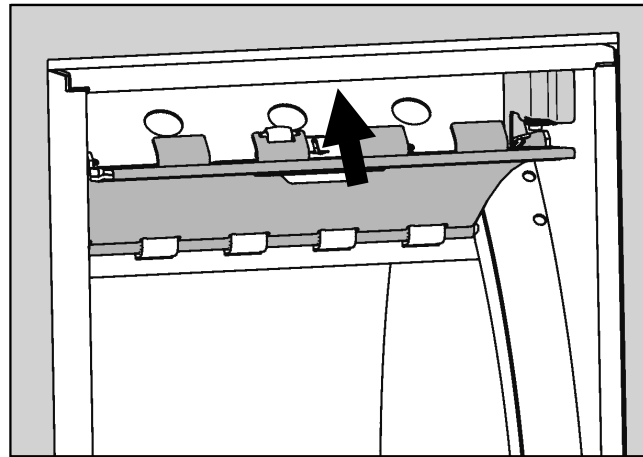

- Press the upper half of the drum door into the catch in the upper part of the door.

Loading the laundry

Check the drum for pets or foreign objects before loading it with laundry.

- Unfold the laundry and load loosely into the drum.

Mixing both large and small items gives better wash results and also helps to distribute the load evenly during spinning.

- Please note the maximum load size for different wash programmes. The relevant load size is always shown in the display when you select a programme.

Closing the drum

⚠ Risk of damage due to drum not being closed.
If the following procedure is not observed, the drum may open during the wash programme and cause damage.
Ensure that the drum is closed properly before starting a wash programme.

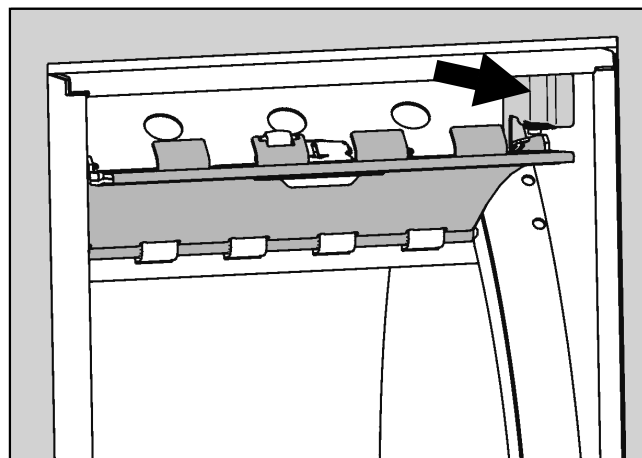

- Release the upper half of the drum door from the catch.

Washing

Be careful not to trap any items of laundry in the drum when closing it.

- First close the lower half of the drum door with the locking mechanism.
- Then close the upper half of the drum door until the locking hooks clasp together and engage.

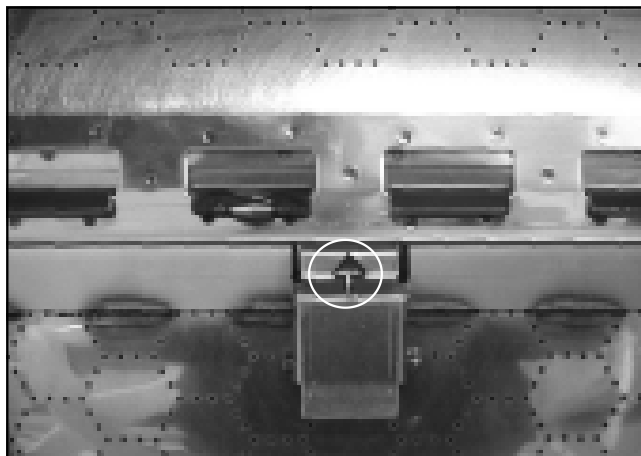

The arrow must be fully visible on the locking mechanism. Only then is the drum door closed properly.

Closing the hinged door

It is essential to close the hinged door of the clean side again after unloading.





- Push down the hinged door on the clean side with both hands on the door handle.
- Push the door handle downwards.

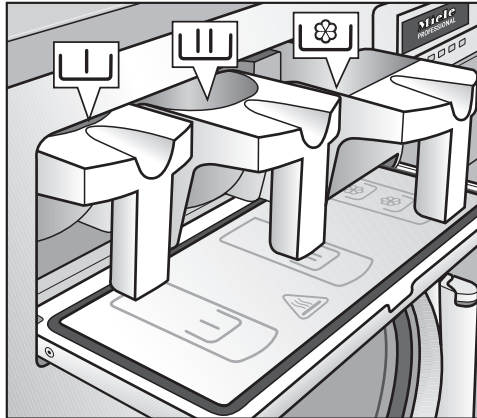

Adding detergent

- Open the detergent drawer.

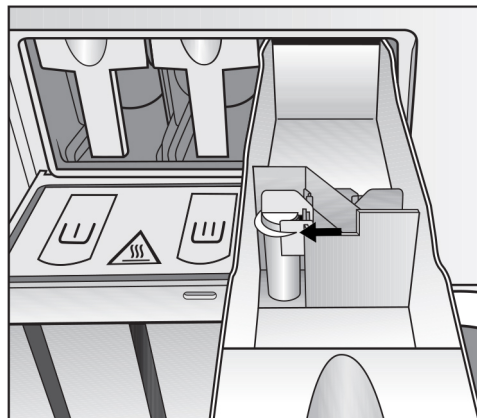

- Pull out the required detergent drawers and add the appropriate detergent:
 -  Detergent for the pre-wash
 -  Detergent for the main wash and soaking
 -  (front compartment) Fabric conditioner or liquid starch





- Do not add cleaning agents beyond the marking in the  drawer; otherwise they will run into the suds container.
- Add any other liquid cleaning agents to the rear compartment of the  drawer (if this has been programmed).

Washing

Bleaching agents

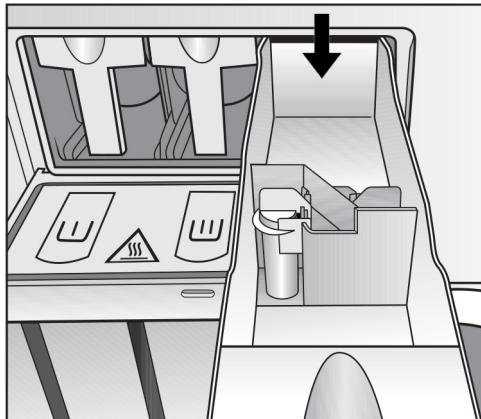
Only use bleach on fabrics with the \triangle symbol on the wash care label.



Only pour liquid bleaching agents into the rear compartment of the  drawer. This is the only way to ensure that the bleaching agent is added automatically during the second rinse cycle. Liquid bleaching agents should only be used on coloured items which have a wash care label stating that they are suitable for bleaching.

For bleaching, a third rinse cycle must also be programmed (see programming instructions).

 Damage due to bleaching agents with chlorine. Frequent use of chlorine products increases the risk of damage to components.

Only use dyes, dye removers and descaling agents suitable for use in a washing machine. The manufacturer's instructions on the packaging must be observed.

Detergent dispensing

Always ensure the correct amount of detergent is used. Adding too much detergent will lead to excessive foaming.

Follow the detergent manufacturer's instructions and only use low-foaming detergents.





The correct quantity to be dispensed depends on the following factors:

- The amount of laundry
- How dirty the laundry is
- The water hardness

Water hardness level	Water properties	Total hardness (mmol/l)	Total hardness (°d)
I	Soft	0–1.3	0–7
II	Medium	1.3–2.5	7–14
III	Hard	2.5–3.8	14–21
IV	Very hard	> 3.8	> 21

Check with your local water supplier if you do not know the water hardness level in your area.

Selecting a programme

23	Separate drain		
7	Cottons hygiene	90°C	
8	Cottons universal	60°C	
			

Selected programme (example): Cottons hygiene

- Rotate the rotary control to select the desired programme.

The selected programme is highlighted.

- Press the rotary control to confirm the selected programme.

The **start** button flashes.

If required, you can now select additional functions or make programme modifications. You can also start the programme immediately without making any modifications by pressing the **start** button.

Additional functions

Selecting a Pre-wash

- Press the  function button to select the Pre-wash additional function.



The  symbol is highlighted.

- Press the  function button again if you want to reselect the Pre-wash function.

Starching the laundry

The Starch additional function can be selected before the programme starts in all programmes (with the exception of the Separate spin and Separate drain programmes).

- Press the  function button to select the Starch additional function.

The  symbol is highlighted.

Press the  function button again if you want to reselect the Starch function.

Adding starch

There is a programme stop before the laundry is starched. The message Prog. stopped. Starch stop pressed. The door can be opened will appear in the display.

- Prepare the starch according to the manufacturer's instructions. Dilute the starch with water if necessary.
- Add the starch prepared according to the manufacturer's instructions to the front compartment of the  drawer. Alternatively, you can open the hinged door and add the starch directly to the drum. Close the drum and hinged door once you have added the starch.
- Press the start button.

The programme continues. The Starch additional function automatically extends the wash time by approx. 4 minutes.

Deactivating the spin cycle

- Press the  function button to switch off the automatic spin cycle after the rinse cycle.

The  symbol is highlighted.

- Press the  function button again if you want to reactivate the Spin function.

Setting a start time

The  function button can be used to set an individual start time for a wash programme.

Setting the start time

- Select the wash programme required.

Washing

The following message (for example) is shown in the display after selecting the programme:

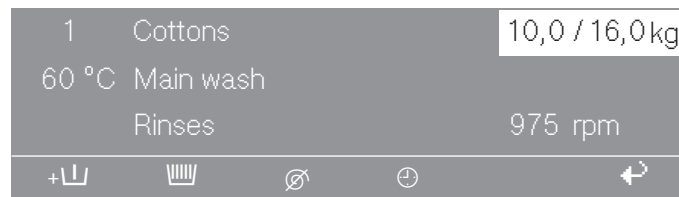

Example display after the programme selection

- Press the  function button.

You can now set the start time and start date for the programme. The current time and date are preset. The “Hour” entry field is highlighted.

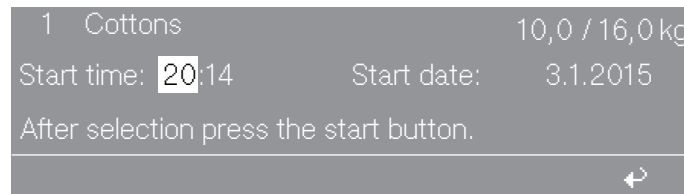

Display example with highlighted “Hour” entry field

- Press the rotary control.

The “Hour” entry field can now be changed using the rotary control.

- Rotate the rotary control until the desired value has been reached.
- Press the rotary control to confirm the selected hour.

You can then change the minutes if required.

- Rotate the rotary control until the “Minutes” entry field is highlighted and press the rotary control.
- Rotate the rotary control until the desired value has been reached.
- Press the rotary control to confirm the selected minutes.

The start time has now been set.

Setting the start date

- Rotate the rotary control until the “Start date day” entry field is highlighted and press the rotary control.
- Rotate the rotary control until the desired day has been reached.
- Press the rotary control to confirm.
- You can also change the month and year using the rotary control if required.
- Press the **Start** button.

The display shows the current time and date on the left and the set programme start time on the right.

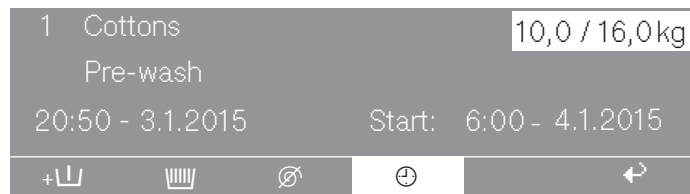

Display example after setting a start time

If the hinged door is opened after setting the start time, the start button must be pressed again.

■ Cancelling the start time function
■ To cancel the start time function, press the ⊕ function button or the ↶ function button.

The changed settings for the start time are not saved.

Washing

Temporarily changing the language The display language can be changed temporarily via the flag symbol before starting the programme.

The language selected is reset 5 minutes after the end of the programme when the door is opened.



- Press the  function button.

The following appears in the display:



- Press the rotary control to confirm the Language menu option.



- Rotate the rotary control to select the desired language.

The selected language is highlighted.

- Press the rotary control to confirm the new display language.

The display is now shown in the newly selected language.

Programme modifications

Changing the load size

The load size can be changed manually before the start of the programme.

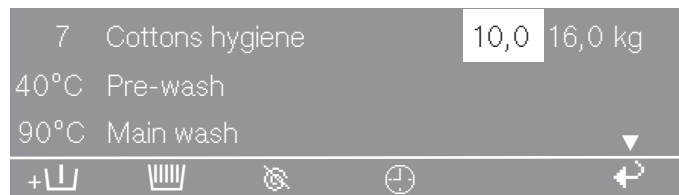

Display with highlighted "Load size" entry field

- Rotate the rotary control until the "Load size" entry field is highlighted.
- Press the rotary control to confirm.

The load size can now be changed using the rotary control.

- Rotate the rotary control to change the load size.
- Press the rotary control to confirm the set load size.

Changing the temperature



Display with highlighted "Temperature" entry field

- Rotate the rotary control until the "Temperature" entry field is highlighted.
- Press the rotary control to confirm.

The temperature of the wash programme can now be changed using the rotary control.

- Rotate the rotary control until the required temperature has been set.

The temperature can be set in 1 °C intervals from 15 °C to 95 °C or to "cold".

- Press the rotary control to confirm the set temperature.

Altering the spin speed

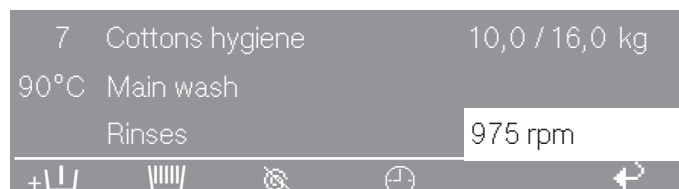

Display with highlighted "Spin speed" entry field

- Rotate the rotary control until the "Spin speed" entry field is highlighted.
- Press the rotary control to confirm.

The spin speed can now be changed using the rotary control.

Washing

- Rotate the rotary control until the required spin speed has been set.

Depending on the model of the machine, the spin speed can be changed in 25 rpm increments from 300 rpm to a maximum of 1025 rpm (PW 6323) or 975 rpm (PW 6243/6163).

- Press the rotary control to confirm the set spin speed.

Starting the programme

The start button flashes when the programme can be started.

- Press the start button.

The door will lock and the wash programme will start.



Display after programme start (example)

The programme status will appear in the display.

The current wash programme is displayed in the second line of the display ("Pre-wash" in the image above). Next to it, the current suds temperature appears on the right ("20 °C" in the image above).

The next wash programme is displayed in the third line of the display ("Main wash" in the image above). Next to it, the estimated time at the end of the programme is displayed on the right ("12:35" in the image above).

Displaying additional programme information

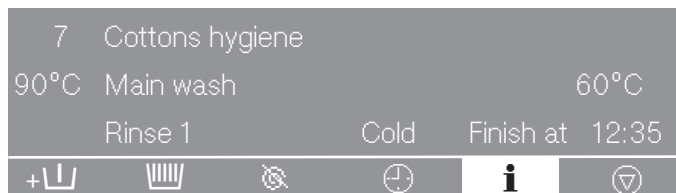

- Press the **i** function button to display additional information about the wash programme.

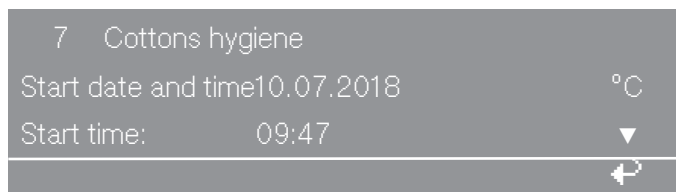

Display after pressing the **i** function button (example 1)

Time after start	7	
Time left	10.07.2018	°C
Time after start	09:47	▼
		↶

Display after pressing the **i** function button (example 2)

- Press the  function button to return to the programme status.

End of the programme

Depending on the selected wash programme, the laundry can be removed on either the clean or unclean side.

For locked wash programmes, the laundry can only be removed from the clean side.

End of programme (removal on unclean side)

At the end of the programme, a message appears in the display indicating that the laundry can be removed on the unclean side.

7	Cottons hygiene
Programme finished	
Unload drum - UNCLEAN SIDE	
⊕  ↶	

Display at the end of a programme (example)

End of programme (removal on clean side)

Locked wash programmes always finish on the clean side.

At the end of the programme, a message appears in the display indicating that the laundry can be removed on the clean side.

2	Thermal disinfection RKI
Programme finished	
Unload drum - CLEAN SIDE	
⊕  ↶	

Display at the end of a programme (example)

End of programme (clean side without display) Opening the hinged door at the end of the programme

The green indicator light flashes at the end of the programme. A buzzer sounds at the same time.

- Pull the door handle upwards.
- Pull the hinged door upwards.

The gas pressure stays push the hinged door up.

Washing

Opening the drum



- Press the locking mechanism with your thumb.
- Press the two halves of the drum door simultaneously until they are unlocked.
- Open the two halves of the drum door outwards.

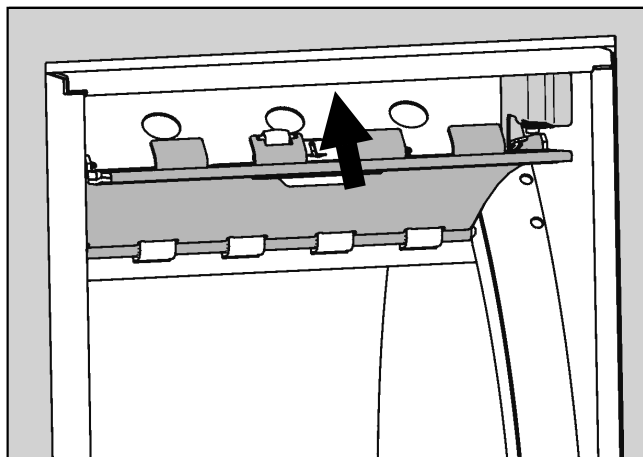

- Press the upper half of the drum door into the catch in the upper part of the door.
- Remove the laundry from the drum.

Removing the laundry and closing the drum

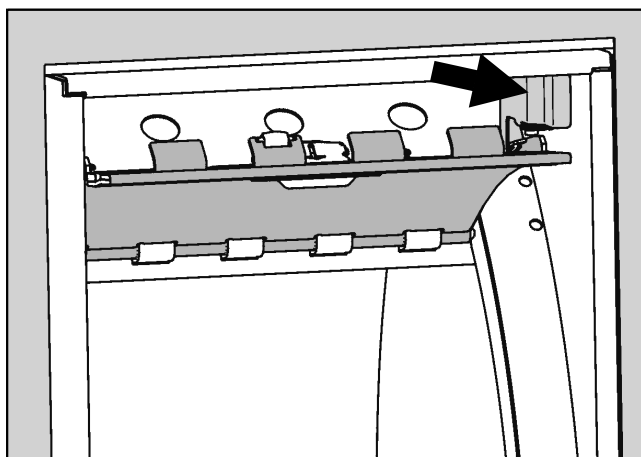

- Release the upper half of the drum door from the catch.

- First close the lower half of the drum door with the locking mechanism.
- Then close the upper half of the drum door until the locking hooks clasp together and engage.

Closing the hinged door

It is essential to close the hinged door of the clean side again after unloading.



- Push down the hinged door on the clean side with both hands on the door handle.
- Push the door handle downwards.

When the hinged door is closed on the clean side, the drum automatically moves to the unclean side.

Moving the drum door to the clean side

The Drum locating programme can be used to manually transfer a laundry load in the drum to the clean side. However, the supervisor must take personal responsibility for ensuring that the laundry load is hygienically acceptable.

- Start the Drum locating programme.

The drum door is turned from the unclean side to the clean side and locked.

Finishing cancelled programmes

Perform the following steps if a wash programme was interrupted with water in the drum or during the spin cycle. In this case, either Programme finished. Water in the drum. or Programme finished. Drum still rotating. appears in the display.

Removing water from the drum

- Press the  function button when the message Programme finished. Water in the drum. appears in the display. Otherwise, you can skip this step.

The water will drain away.

Washing

Starting an additional spin programme

- Select the Separate spin programme.
- Press the start button.

The washing machine runs the spin programme.

The programme finishes on the unclean side.

Switching off the washing machine

To allow the washing machine to dry out after use, do not close the hinged door on the unclean side after washing.
Leave the hinged door ajar after washing.

- Switch the washing machine off by pressing the **0** button.
- Switch off the on-site power switch.
- Close all on-site shut-off valves for water or steam.

Washing with a programme card

Cards with a programme saved on them are intended for a particular model of washing machine. Blank cards can be used in any machine.

⚠ Damage due to insertion of unsuitable objects.
The card reader can be damaged if other objects (e.g. coins or tokens) are inserted into the card reader.
Only insert appropriate programme cards into the card reader.

- Press the **I** button to switch on the washing machine.

The welcome screen will appear in the display.

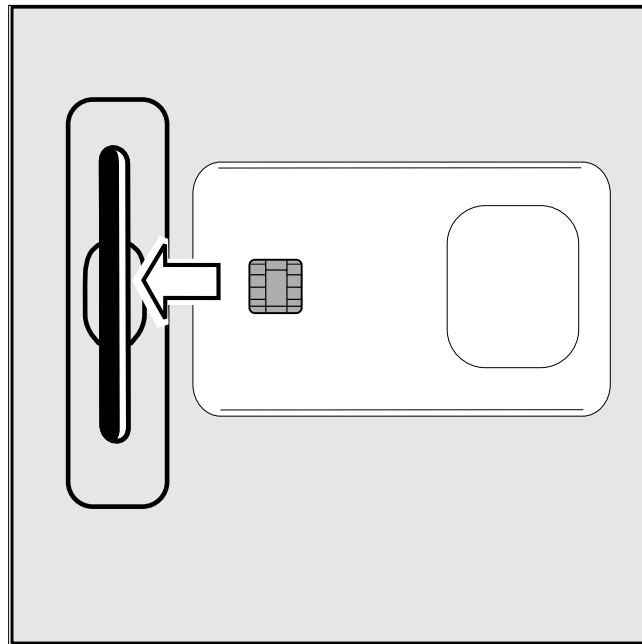

- Insert the card into the card reader.

A list containing the programmes on the card now appears in the display.

Selecting a programme

- Turn the rotary control to select the required programme.

The selected programme remains highlighted.

- Press the rotary control to confirm.

The **start** button flashes.

- Press the **start** button to start the programme.

Once the **start** button has been pressed, the programme card can be removed from the card reader. The programme will be deleted at the end of the programme.

Washing by card operation

Fixing card errors

Card errors are indicated by a message in the display.

When the message `Card incorrectly inserted in card reader.` appears in the display, the card has been inserted into the card reader the wrong way round.

- Remove the card from the card reader.
- Insert the card into the card reader correctly.

When the message `Programmes on the card are not suitable for this machine type.` appears in the display, a card for another machine has been inserted into the card reader.

- Remove the card from the card reader.
- Use a card with programmes that are suitable for your machine.

Laundry load operation

Laundry loads that require a special wash programme are assigned a programme card containing only the programme designed for the specific laundry load.

Laundry load operation can be activated via the `Card access` menu option in the supervisor level.

When the `Card access` menu option is activated, the controls will only accept cards that contain a laundry load programme. The programmes saved on the machine can no longer be accessed.

Temporarily changing the language

The display language can be changed temporarily via the flag symbol before starting the programme.

The language selected is reset 5 minutes after the end of the programme when the door is opened.

1	Cottons hygiene	90°C	
2	Cottons universal	60°C	
3	Cottons intensive	60°C	
			

- Press the  function button.

The following appears in the display:

Settings	Back 	
Main menu	Language 	
Supervisor level		
		

- Press the rotary control to confirm the Language menu option.

Settings	dansk	
Language 	english (GB)	
english		
		

- Rotate the rotary control to select the desired language.

The selected language is highlighted.

- Press the rotary control to confirm the new display language.

The display is now shown in the newly selected language.

Additional functions

Start time

A later wash start time can be allocated to a programme using the  “Start time” function button.

Setting a start time ■ Select the wash programme.

When a programme has been selected, the following (for example) will appear in the display:

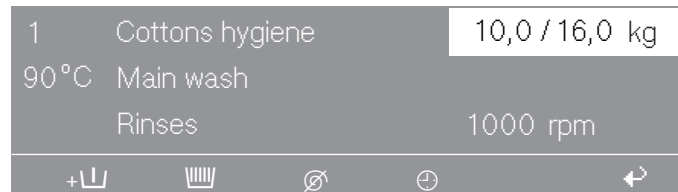

■ Press the  “Start time” function button.

The following (for example) will appear in the display:

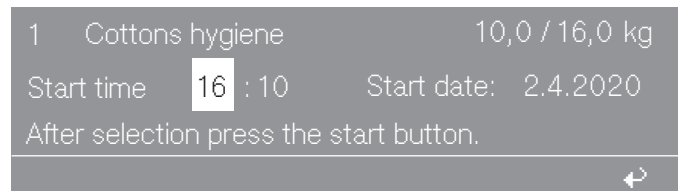

The current time and date always appear. The entry field for hours is highlighted.

- Press the rotary control to select the hour. Rotate the rotary control to change the hour and press the rotary control to confirm.
- Rotate the rotary control to select and confirm the “Minutes” field. Rotate the rotary control to change the minutes and press to confirm.
- Rotate the rotary control to select and confirm the “Start date day” entry field. Rotate the rotary control to change the day and press to confirm.
- Change the month and year if required.
- After setting the start time, press the “START” button and the programme will start at the set time.

The display shows the current time and date and the start time.

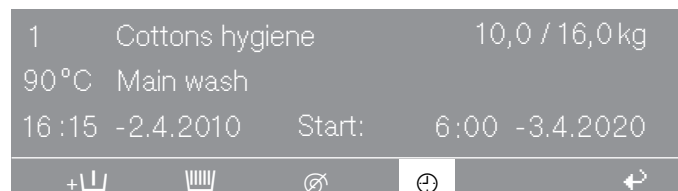

If the drum door is opened again, the “START” button must be pressed again.

Canceling the start time

■ Press the  “Start date and time” button or the  “Back” button.

The changes will not be saved.

With pre-wash

A Pre-wash can be added for heavily soiled laundry before the programme has started in the standard programmes 1 to 10.

- Press the + “Block+” button.

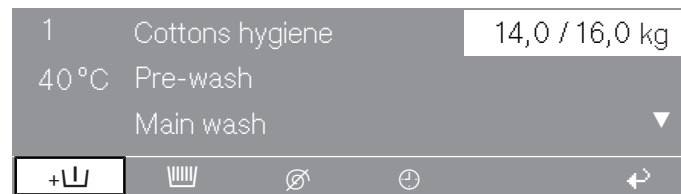

The following will appear in the display:



The “+” field is highlighted in the display.

Tip: The function can be deselected by pressing the + “Block+” button again.

Adding via the drawer

Starching can be selected before the programme starts in all standard programmes (excluding Separate spin and Separate drain) by pressing the  “Starch stop” button. The  field will be highlighted in the display.

The function can be deselected by pressing the button again.

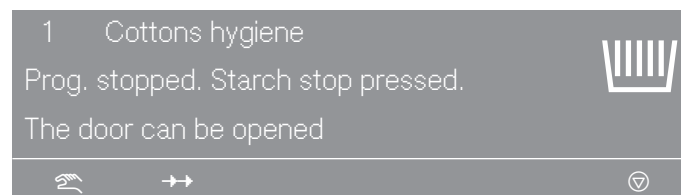

When the “Starch stop” programme stage is reached, Prog. stopped. Starch stop pressed. will flash in the display.

Prepare the starch according to the manufacturer’s instructions and add to the inflowing water via the front  drawer. Dilute the starch with water if necessary. The wash time will be automatically extended by 4 minutes.

The programme will continue when the “START” button is pressed.

Adding directly into the drum

When the “Starch stop” programme stage is reached, open the drum door and add the starch prepared according to the manufacturer’s instructions. Close the drum door.

The following message appears in the display:

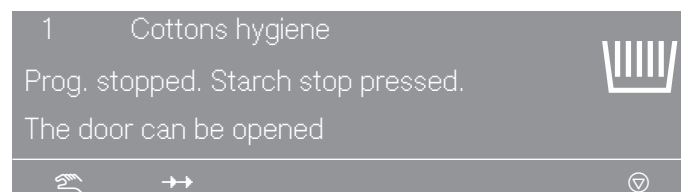

Press the “START” button and the programme will continue.

Additional functions

Without spin

“Without spin”  can be selected before the programme starts in all standard programmes (excluding Separate spin).

- Press the “Without spin” button.

The  field will be highlighted in the display.

Tip: The function can be deselected by pressing the button again.

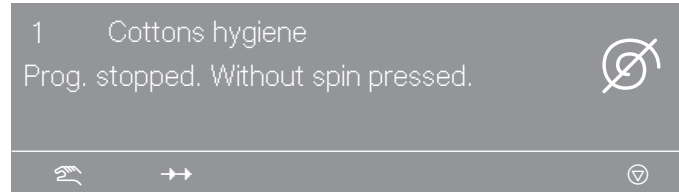

When the “Without spin” programme stage is reached, Prog. stopped. Without spin pressed. will flash in the display.

- End the programme without a spin and with Water in the machine by pressing the  “Stop/finish” button.

Tip: The programme can be continued with a spin by pressing the “Start” button.

Programme stop

Stopping the programme.

- Press the  “Stop/finish” button to stop the programme.

The programme is stopped.

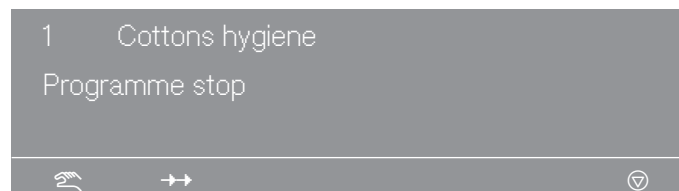

Tip: The programme can be continued by pressing the “START” button.

Programme cancellation

The programme can be cancelled as follows.

- Press the  “Stop/finish” button twice in succession.

The programme is cancelled.

If the programme has been cancelled while there is still water in the machine or during spinning, the following will appear in the display:

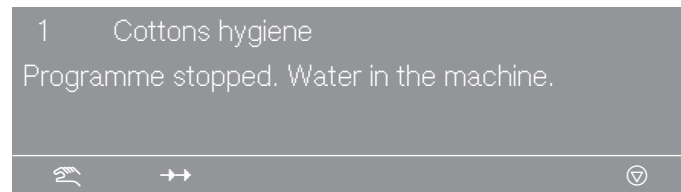

or

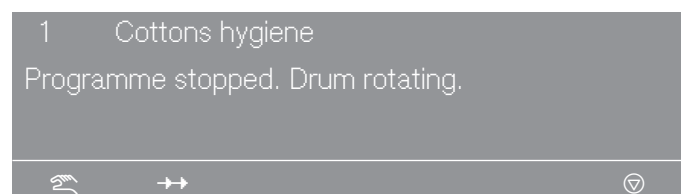

Tip: To open the door, press the “Water drainage”  function button or select the “Separate spin” programme and press the “START” button.

Cancelling a locked programme

It is not possible to stop or cancel a locked programme.

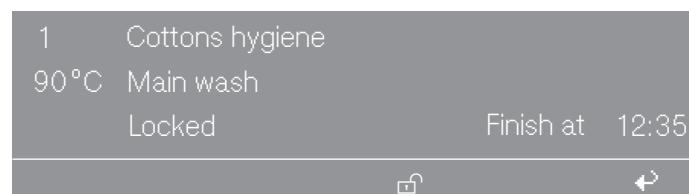

The display will show the locked state if an attempt is made to cancel the programme by pressing the  “Stop/finish” button.

- Press the  “Unlock” function button and enter the password.

When the password is entered, the following appears in the display:

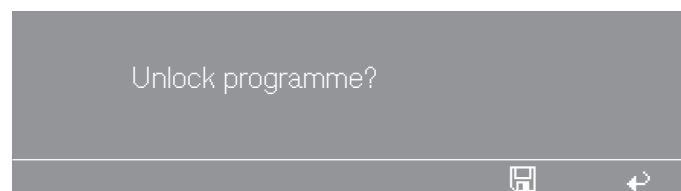

- Press the  “Save” button.

The normal display content will appear and the programme can now be cancelled.

Additional functions

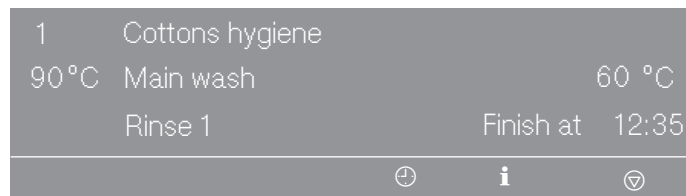

Skipping a programme

The current programme can be skipped or programme blocks can be repeated.

- Press the ⊖ “Stop/finish” button.

The programme is stopped.

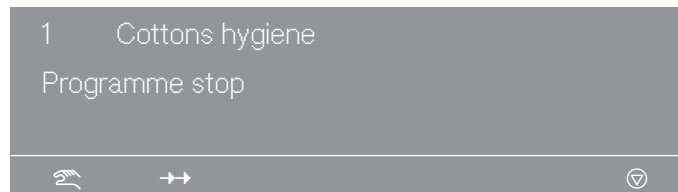

- Press the →→ “Change order” button.

The current area, block or stage appears in the display.

Tip: See “Programme structure” for more information.

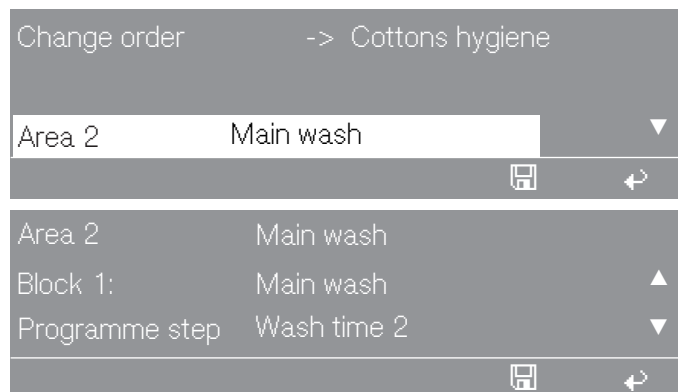

- Rotate the rotary control to highlight Area and press to confirm. Select and confirm areas: 1 Pre-wash, 2 Main wash or 3 Rinse.
- Rotate the rotary control to highlight Block and press to confirm. Select and confirm blocks: 1–10 Pre-wash, 1–10 Main wash or 1–10 Rinse.
- Rotate the rotary control to highlight Stage and press to confirm. Select and confirm the required programme stage.
- Press the ⊞ “Save” button and then “START” to skip the stage.

Tip: Press the ↶ “Back” button to return to programme stop and the Change order will not be performed.

Liquid dispensing (optional for machines with dispenser compartment)

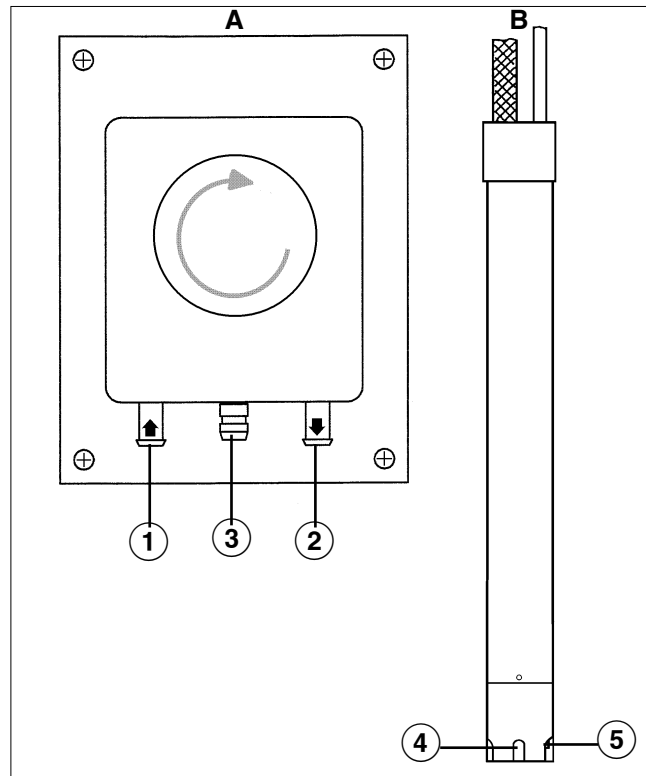

A Dispenser pump

B Siphon

- ① Hose connection (suction side)
- ② Hose connection (pressure side)
- ③ Leakage outlet
- ④ Suction inlet opening
- ⑤ Empty indicator. When the dispenser is empty the pump and the machine switch themselves off.

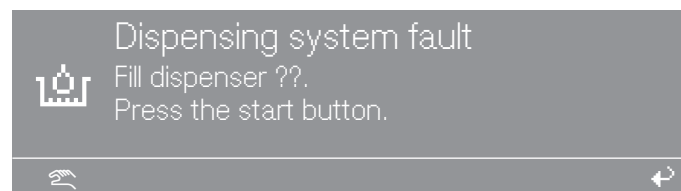

At the same time, the washing machine indicates a lack of liquid detergent. When the dispenser canister has been filled, the programme can be started by pressing the “START” button.

Deselecting dispensing

Liquid dispensing can be switched off before the programme starts.

Optional modules

1	Whites	90 °C
2	Cottons	60 °C
3	Cottons Intensive	60 °C

- Switch liquid dispensing off manually using the “Dispensing off” function button.
- After the programme has started, no detergent will be dispensed via the dispensing pumps and the following message (for example) will be displayed:

1	Cottons hygiene	10,0 / 10,0 kg
90 °C	Main wash	
	Rinses	1000 rpm

Amount to be dispensed

Please follow the detergent manufacturer's instructions.

⚠ Risk of injury!
 Strong chemical reactions and material damage.
 It is particularly important to observe manufacturer's instructions when using a combination of cleaning agents and special application products. Products must only be used for applications approved by the manufacturer to avoid any material damage or the occurrence of strong chemical reactions. Confirmation must be sought from the detergent manufacturer that using the agent in the washing machine will not cause damage.

Tip: Correct dosage also depends on the viscosity of the liquid agent. It should therefore be allowed to settle to room temperature before being used.

Commissioning the dispensing pumps

Dispenser calibration

Before the liquid dispensing pumps can be used the liquid agent must be drawn into the system and the amount to be dispensed set.

Dispenser calibration is used to measure the throughput of the individual dispensing pumps.

To go directly to Dispenser calibration when the machine is switched off:

- Press and hold multifunction button 2 and switch the machine on with I “Power on”.

Dispenser calibration	▶ Main menu
Dispenser pump 1	
Dispenser pump 2	▼

Options:

- Dispensing pump 1 to 13
- Select a dispensing pump.

When a dispensing pump is selected, the following will appear in the display:



Tip: The dispensing quantity can be set from 0 to 9999 ml in 1 ml increments.

- Press the multifunction button 0/1.

The dispensing hose will fill up.

- Stop the process by pressing the 0/1 button.
- Run the hose of the dispensing pump upwards into a measuring vessel.
- Hold the entire measuring vessel above the dispensing pump while doing this.

⚠ Irritant detergents.
Skin and eye irritation.
Avoid contact with skin and eyes, wear protective clothing.

- Return to the main menu by pressing the  “Back” button.

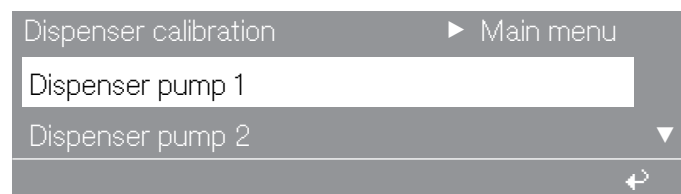

- Select a dispensing pump.



- Press the multifunction button 0/1.

Stop the pump by pressing the 0/1 button, or the pump will stop automatically after 60 seconds.

- Measure the required amount in the measuring vessel.

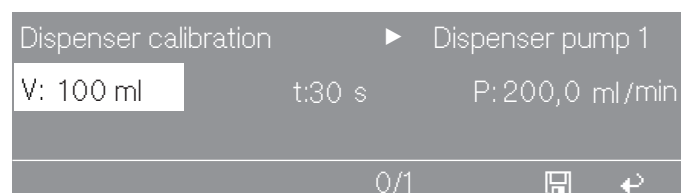

- Enter the amount measured in the V: field.

The throughput P is calculated in ml/min by the controls.

Optional modules

Cleaning and maintenance of the dispensing system

- Press the  “Save” function button.

The measured value is assigned to the pump.

- Reattach the hose.

Rinse the dispensing system through with hot water every 2 weeks, or before shutting the dispenser pumps down for any length of time, to avoid the system getting clogged up and corroded.

- Also rinse out the siphons with water.
- Put the siphons in a container of warm water (40-50 °C).
- Use dispenser calibration to activate each pump until the dispensing system is rinsed through.
- Check the connection points, hoses, dispensing sockets and washers for leaks.

Peak-load negotiation

When the peak-load function is activated, the heating is deactivated and the programme stopped.

- Activate the peak-load function.

The following message appears in the display:

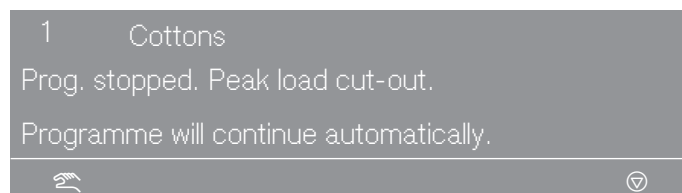

The programme is resumed automatically when the peak-load function finishes.

Communication module

The machine can be connected to a PC (personal computer) using the communication module.





The slot for the communication module is located on the back of the machine.

An Editor programme is available for this from your sales and service centre or your Miele dealer.

Operating data

With the Operating data module, Operating data can be read or deleted via the  “Operating data” button either before programme start or at the end of the programme.

1	Cottons hygiene	90 °C
2	Cottons	60 °C
3	Cottons Intensive	60 °C

- Press the  “Operating data” button.

When the  button is pressed, the following appears in the display:

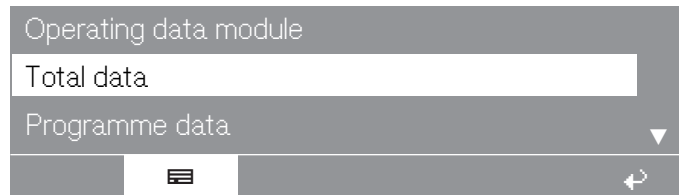

You have the following options:

- Total data
Data from all programmes is collected and added together in Total data.
- Programme data
Programme data is data which is recorded during a programme.
- Delete data
- Module (delete total data and programme data)
- Total data (only delete total data)
- Programme data (only delete Programme data)

Tip: The function can be deselected by pressing the  “Operating data” button again.

If the data storage capacity in the Operating data module is full, a message appears when the “START” button is pressed to inform you that Operating data will be overwritten.

Tip: If the  “Back” button is pressed or if the “START” button is not pressed within 30 seconds, the programme will not start and the display appears as before programme start.

Total data

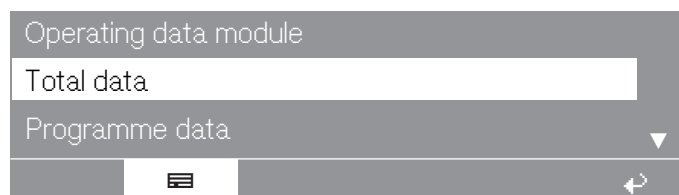

- Select the Total data menu option.

After selecting Total data (for example), the following appears in the display:

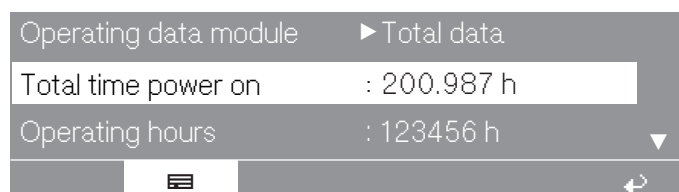

Further options:

- Total time power on: 200,987 h

Optional modules

- Operating hours: 123,456 h
- Duration heating active: 73,456 h
- Duration drive motor active: 93,456 h
- Programme starts: 23,456
- Programme stops: 567
- Programme cancellations: 67
- Water volume: 1,234,567 l
- Load: 1,234,567 kg
- Liquid agent: 2345 l
- Energy: 12,345,678 kWh

Programme data

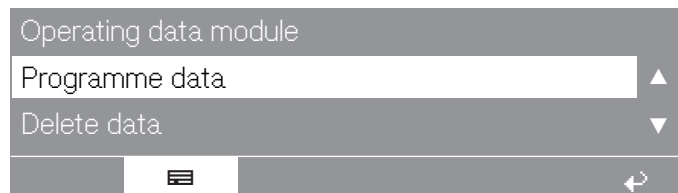

- Select the Programme data menu option.

After selecting Programme data (for example), the following appears in the display:

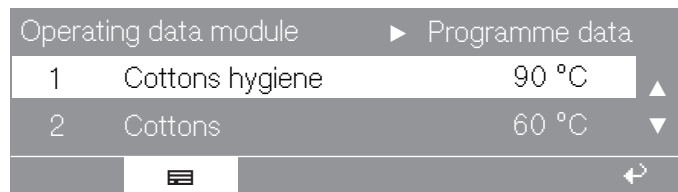

- Select the relevant programme from the programme list and confirm your selection by pressing the rotary control.

A list of all programme starts of “Programme ► 1 Cottons hygiene” will then appear with the date and start time.



- Select the programme start you want from the list of all “Programme ► 1 Cottons hygiene” programme starts and confirm your selection by pressing the rotary control.

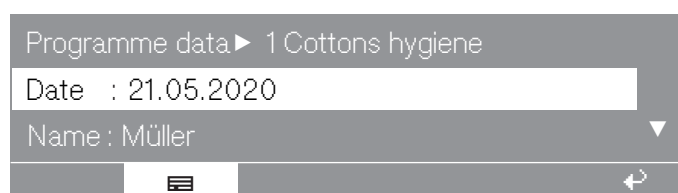

Further options:

- Town: **Lehrte**
- Serial number: **12345678**
- Machine type **PW 6321**
- Load: **13 kg**
- + button: **pressed**
- Starch stop button: **pressed**
- Without spin button: **not pressed**
- Programme start: **11:30**
- Programme finished: **12:05**
- Total operating time: **0 h 35 min**
- Electrical energy: **12.5 kWh**
- Gas energy: **0 kWh**
- Steam energy: **0 kWh**
- Total volume of water: **140 l**
- Max. water temperature: **95 °C**
- Max. drain temperature: **45 °C**
- Programme change: **2** (after selecting and pressing the rotary control, only the last 3 stops and 3 starts are displayed.)
- Programme fault: **none** (only the last 3 faults are saved.)
- Area 1: (after selecting and pressing the rotary control, the area and the block can both be changed.)
- Block 1:
- Operating time: **6 min**
- Water volume: **20 l**
- Dispensing phase 1: **amount ml** (after selecting and pressing the rotary control, the 6 dispensations are displayed.)
- Max. temperature: **12 °C**
- Holding time: **6 min**
- Dispensing phase 2: **No**

Delete data

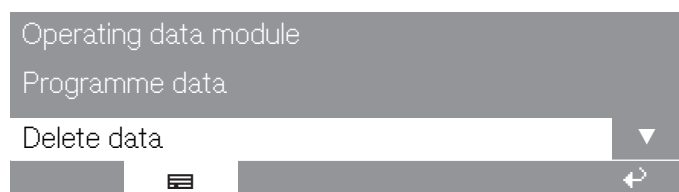

- **Select the Delete data menu option.**

After selecting Delete data, the following appears in the display:

Optional modules

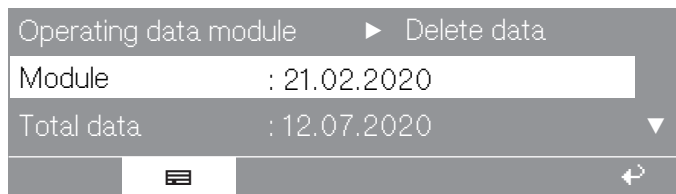

With the **Module** menu option, the **Total data** and the **Programme data** will be deleted from the **Operating data**.

With the **Total data** menu option, only the **Total data** will be deleted from the **Operating data**.

With the **Programme data** menu option, only the **Programme data** will be deleted from the **Operating data**.

- Rotate the rotary control to select one of the menu options and press the rotary control to confirm the selection.

A prompt to enter a password then appears.

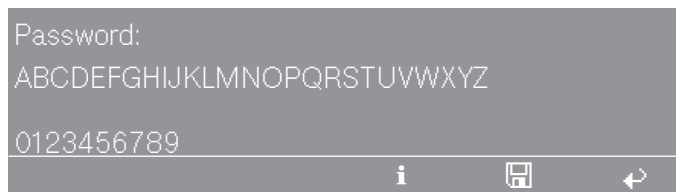

- Enter the password or insert the card for supervisor level.

The menu option is accessed and an additional security question appears.

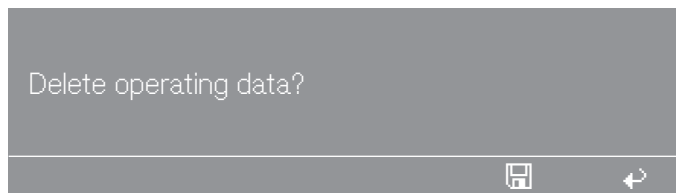

- Press the  “Save” button.

The data is deleted.

Weighing system/weighing plinth

If the machine is equipped with a weighing plinth, the load weight is displayed in 0.2 kg increments during loading. The maximum load weight for the selected programme is displayed beside it.

Resetting the load display to zero

Do not place any items on the machine. Do not lean against the machine.

This can influence the result of the measurement.

If the load display does not show “0.0” with an empty drum, set the display to 0 using the **⇦⇦** button.

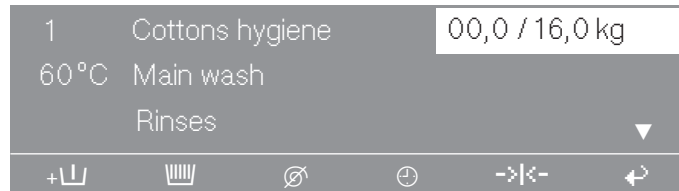

- If after resetting to 0 (taring), you discover an overlooked item in the drum, the following will appear in the display:

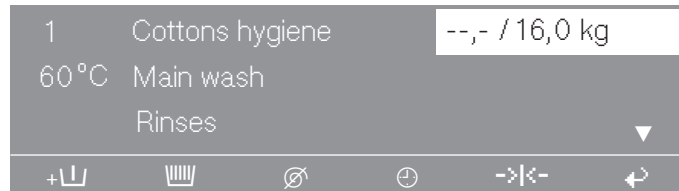

- Reset the display to 0 using the +|< button.

Tip: If the machine is overloaded, for example when laundry is wet, it will operate in accordance with the nominal load after the programme starts. This value is also saved in the operating data module.

At the end of the programme when the drum has stopped rotating, the residual moisture in the laundry is shown in the display.

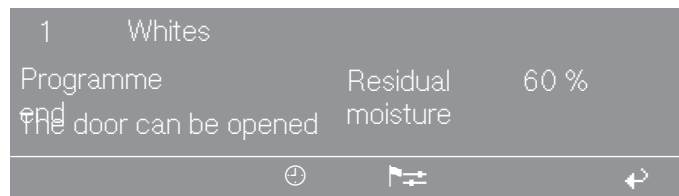

Sampling tap

Some machine models are equipped with a sampling point for suds for analytical purposes in laboratories. The sampling point may only be used by trained personnel.

Special precautions must be taken when using the tap to extract suds:

- Wear personal protective equipment to avoid eye damage, skin damage or respiratory impairment.
- Use suitable and safe collection containers.
- If there are visible leaks, take immediate action to disconnect the machine from the power supply. Remedy the effects of the leak and rectify the cause. The machine can be started up again.

The machine must be emptied using the emergency release drain valve.

- Have the suds tapping equipment (tap, hoses and fastening materials) checked for damage at regular intervals by trained personnel. In the event of damage, the suds tapping equipment must be repaired or replaced.

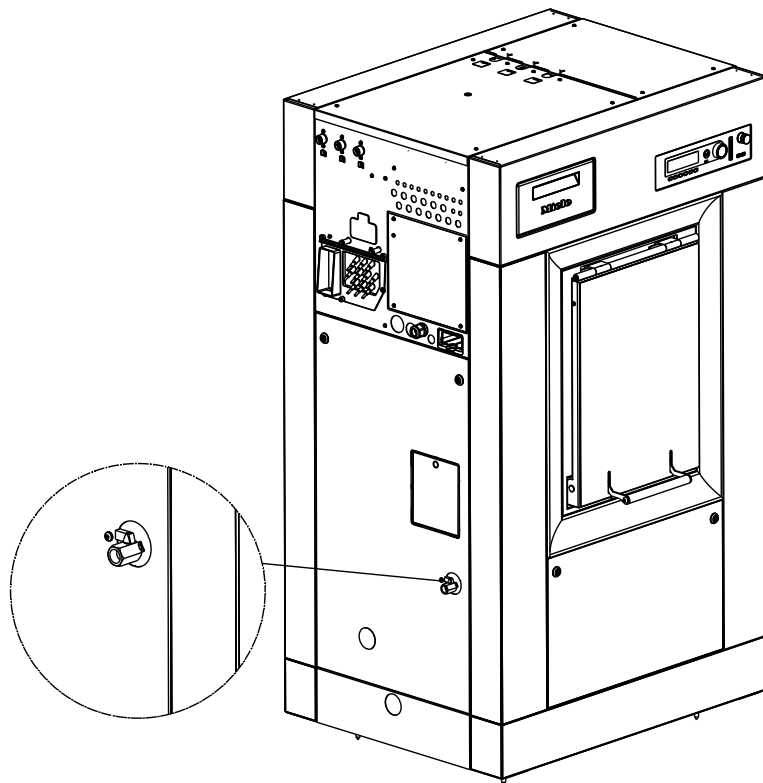

The ball valve on the side of the casing is closed transversely to the flow direction and open longitudinally to the flow direction.

⚠ Depending on the wash programme, the ball valve and the suds may be hot and touching them without protective clothing may result in burn injuries.

The ball valve must remain closed in normal operation. The ball valve may only be opened during operation when necessary for taking samples in accordance with the specified safety instructions.

There may be residual water in the hose system to the ball valve at the end of the programme. Empty the hose system at regular intervals to prevent the risk of germs and contamination.

Problem solving guide

You are able to correct the majority of faults and problems that arise during day-to-day use without external assistance. You can save time and money in many cases, as you do not need to call Miele Service.

The following tables are designed to help you to find the cause of a malfunction or a fault and to resolve it.

Troubleshooting

Problem	Cause and remedy
The display remains dark and the <small>Start</small> button does not flash.	There is no power to the washing machine. <ul style="list-style-type: none">■ Check whether the washing machine is switched on.■ Check whether the washing machine is connected to the power supply.■ Check whether the fuse has tripped.
Brief power failure during the wash cycle. The following message appears in the display once the power supply has been re-stored: Power cut Programme stopped. Press the start button..	There is no power to the washing machine for a brief period. <ul style="list-style-type: none">■ Press the <small>Start</small> button. The programme continues.

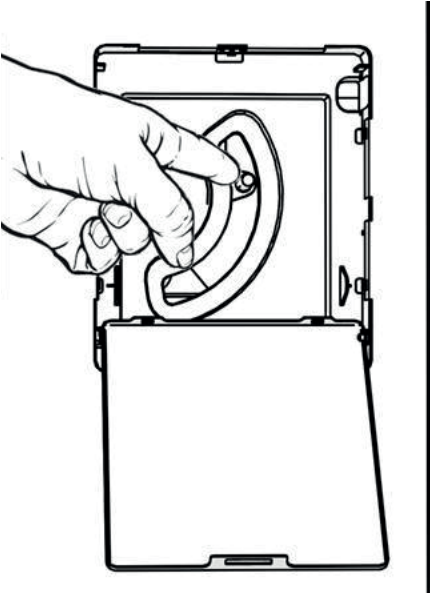
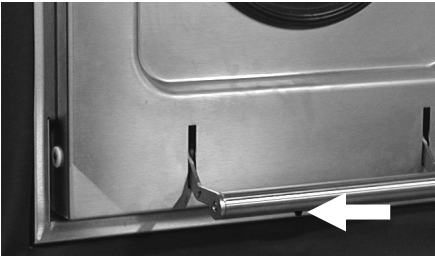
Problem	Cause and remedy
<p>Total power failure during the wash cycle. To remove the laundry, first open the drain valve manually and then manually unlock the door.</p>	<p>There is no power to the washing machine due to a prolonged power failure.</p> <ul style="list-style-type: none"> ■ Switch the washing machine off by pressing the 0 button. ■ Switch off the on-site power switch and close all on-site shut-off valves for water or steam. <div style="text-align: center;">  </div> <ul style="list-style-type: none"> ■ Push the emergency drain lever downwards and hold until no more water runs out. <p>The emergency drain closes automatically when the lever is released.</p> <div style="text-align: center;">  </div> <ul style="list-style-type: none"> ■ Insert a flat-head screwdriver into the opening under the door handle. Rotate the screwdriver anticlockwise and pull the door handle upwards. ■ Rotate the drum by hand until the drum door is reached. <div style="border: 1px solid gray; padding: 5px; margin: 10px 0;"> <p>⚠ Risk of crushing due to the moving drum. The drum is not locked during a power failure and may move during unloading.</p> </div> <ul style="list-style-type: none"> ■ Remove the laundry.
<p>Excessive foaming during the wash cycle.</p>	<p>You are using an unsuitable detergent.</p>





Problem solving guide

Problem	Cause and remedy
	<ul style="list-style-type: none"> ■ Only use detergent formulated for use in commercial washing machines. Domestic laundry detergent is not suitable.
	<p>You are using too much detergent.</p> <ul style="list-style-type: none"> ■ Dispense detergent following the instructions on the packaging and in accordance with local water hardness levels.
	<p>You are using very soft water.</p> <ul style="list-style-type: none"> ■ In areas with water hardness level 1, add less detergent in accordance with the detergent manufacturer's instructions.
	<p>The items of laundry are only slightly soiled.</p> <ul style="list-style-type: none"> ■ For lightly soiled laundry, add less detergent in accordance with the detergent manufacturer's instructions.
	<p>There are residues in the laundry (e.g. from detergent).</p> <ul style="list-style-type: none"> ■ Additionally, pre-rinse the laundry without setting a temperature and using detergent.
	<p>The load size is too small.</p> <ul style="list-style-type: none"> ■ Reduce the amount of detergent.
	<p>The drum speed is too high during the wash cycle.</p> <ul style="list-style-type: none"> ■ Reduce the drum speed and wash rhythm.

Fault messages in the display

Message	Cause and remedy
Service interval Call the Service Department.	The washing machine needs to be serviced by the Customer Service Department. <ul style="list-style-type: none"> ■ Contact the Customer Service Department.
Water inlet fault Call the Service Department if restart does not work.	A fault has been identified in the water inlet. <ul style="list-style-type: none"> ■ Check the stopcock. ■ Switch the washing machine off and on again. Contact the Customer Service Department if a restart does not work.
Door lock fault Call the Service Department if restart does not work.	The door is not closed properly. The door lock could not engage. <ul style="list-style-type: none"> ■ Close the door again. ■ Start the programme again. Contact the Customer Service Department if a restart does not work.
Heating system fault Programme stopped. Press the start button.	A fault has been identified in the heating system. <ul style="list-style-type: none"> ■ Contact the Customer Service Department. Disinfection programmes will be cancelled if this fault message appears. <ul style="list-style-type: none"> ■ Press the start button to continue the programme without heating.
Drive motor fault Programme stopped. Press start. Motor overheating.	The winding protection of the drive motor has been triggered. <ul style="list-style-type: none"> ■ Allow the motor to cool down. ■ Press the start button when the motor has cooled.
Imbalance fault Call the Service Department if restart does not work.	The travel-dependent imbalance switch has been triggered. <ul style="list-style-type: none"> ■ Press the start button. Contact the Customer Service Department if a restart does not work.
Drain valve fault Call the Service Department if restart does not work.	A fault has been identified in the drainage system. <ul style="list-style-type: none"> ■ Check the on-site drainage system. ■ Press the start button. Contact the Customer Service Department if a restart does not work.
Dispensing system fault Fill dispenser ???. Press the start button.	The dispenser canister is empty. <ul style="list-style-type: none"> ■ Fill or replace the dispenser canister. ■ Press the start button. Contact the Customer Service Department if the message continues to be displayed.

Problem solving guide

Message	Cause and remedy
<p>Positioning fault Programme finished. Use the emergency release.</p>	<p>The drum position is not correct at the end of the programme.</p> <ul style="list-style-type: none"> ■ Switch the washing machine off with the 0 button and then back on with the I button. <p>Contact the Customer Service Department if the message continues to be displayed.</p> <ul style="list-style-type: none"> ■ To open the door in an emergency, insert a flat-head screwdriver into the opening under the door handle. Rotate the screwdriver anticlockwise and pull the door handle upwards. ■ Rotate the drum by hand until the drum door is reached. <div style="border: 1px solid gray; padding: 5px; margin: 5px 0;"> <p> Risk of crushing due to the moving drum. The drum is not correctly locked and may move during unloading.</p> </div> <ul style="list-style-type: none"> ■ Remove the laundry.
<p>Positioning fault Call the Service Department if mains interruption does not work. Operate the emergency release.</p>	<p>The drum position is not correct.</p> <ul style="list-style-type: none"> ■ Switch the washing machine off with the 0 button and then back on with the I button. <p>Contact the Customer Service Department if the message continues to be displayed.</p> <ul style="list-style-type: none"> ■ To open the door in an emergency, insert a flat-head screwdriver into the opening under the door handle. Rotate the screwdriver anticlockwise and pull the door handle upwards. <div style="border: 1px solid gray; padding: 5px; margin: 5px 0;"> <p> Risk of crushing due to the moving drum. The drum is not correctly locked and may move during unloading.</p> </div> <ul style="list-style-type: none"> ■ Rotate the drum by hand until the drum door is reached.
<p>Positioning fault Programme stopped. Water in the machine.</p>	<p>The drum position is not correct. There is still water in the washing machine.</p> <ul style="list-style-type: none"> ■ Press the Start button. ■ Press the  function button if the fault persists. <p>The water is drained out of the washing machine.</p> <ul style="list-style-type: none"> ■ To open the door in an emergency, insert a flat-head screwdriver into the opening under the door handle. Rotate the screwdriver anticlockwise and pull the door handle upwards. ■ Rotate the drum by hand until the drum door is reached. <div style="border: 1px solid gray; padding: 5px; margin: 5px 0;"> <p> Risk of crushing due to the moving drum. The drum is not correctly locked and may move during unloading.</p> </div> <ul style="list-style-type: none"> ■ Remove the laundry.

Contact in case of malfunction

In the event of any faults which you cannot remedy yourself, please contact your Miele Dealer or Miele Service.

Contact information for Miele Service can be found at the end of this document.

Please quote the model and serial number of your appliance when contacting Miele Service. This information can be found on the data plate.

Cleaning and care

Carry out cleaning and maintenance after using the washing machine if possible.

⚠ Risk of electric shock.

Only ever perform cleaning and maintenance work when the appliance is disconnected from the power.

Disconnect the washing machine from the mains electricity supply.

Cleaning the casing and fascia panel

⚠ Damage caused by detergents.

Solvent-based cleaning agents, abrasive cleaners, glass cleaners or multi-purpose cleaning agents can cause damage to plastic surfaces and other parts.

Do not use any of these cleaning agents.

⚠ Risk of damage due to ingress of water.

The pressure of a water jet can cause water to get into the washing machine, resulting in damage to components.

Do not spray the washing machine with a water jet.

- Clean the casing and fascia panel with a mild cleaning agent or soap and water and dry both with a soft cloth.
- The drum and any other stainless steel components can be cleaned using a suitable stainless-steel cleaning agent.

Cleaning the detergent drawer, detergent compartments and siphons

- Clean the detergent drawer and the detergent compartments thoroughly with hot water as required to remove detergent residues and incrustations.
- If the machine is not going to be used for a long time, leave the flap of the detergent drawer open.
- Also clean the siphons in the compartments for cleaning agents.

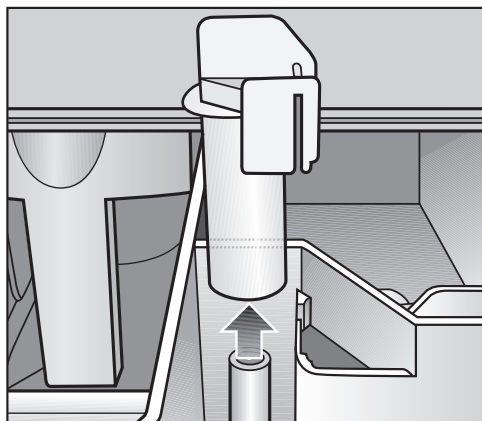

- Remove the siphon. Clean the siphon with hot water and reinsert it.

Cleaning the drip channel and siphon

- Open the flap on the detergent drawer to an angle of 45° and lift out the flap of the detergent drawer on the right side.

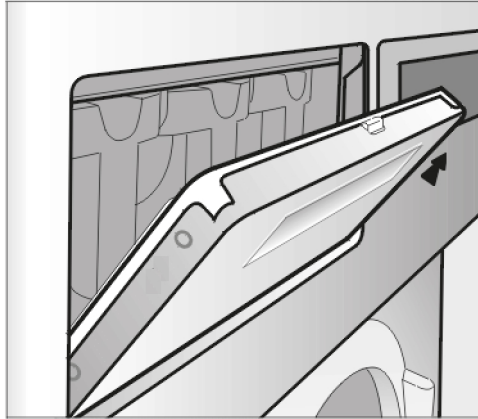

If the drip channel and associated drain connection are blocked, clean them.

- Check the vapour extraction grille on the rear of the machine for contamination from time to time and clean when necessary.

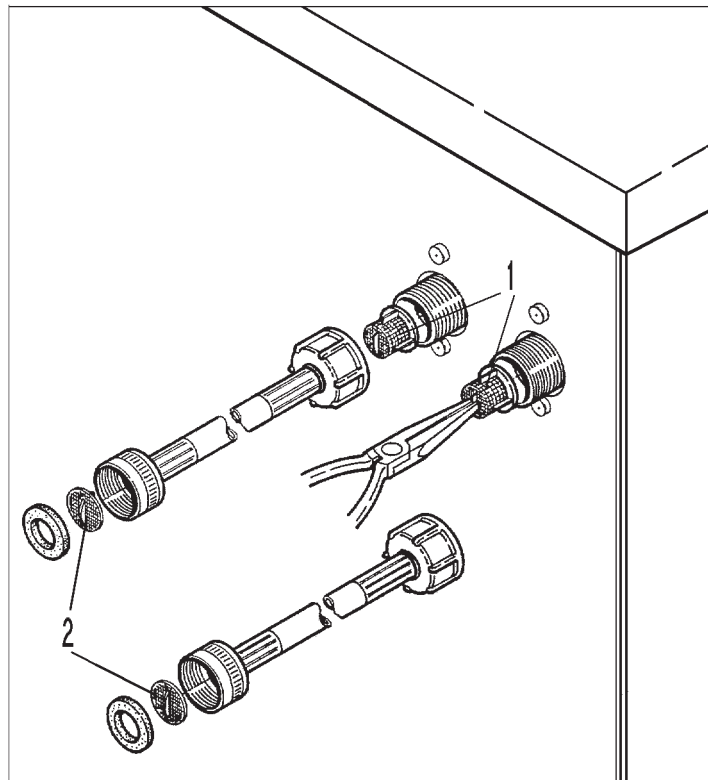

- The filters in the water intake valves (1) and the inlet hoses (2) must be checked for contamination from time to time and cleaned as necessary.

Cleaning the ventilation grilles

Clean the suds container ventilation grille on the side panel of the washing machine occasionally.

Cleaning and care

Checking the closing device

Check the condition of the drum's closing device regularly.

If there is lint on the drum door, remove the lint.

Treating rust

The drum and the suds container are made of stainless steel. Water containing iron or ferrous foreign objects (e.g. paper clips, iron knobs or iron shavings) can lead to rust formation.

Clean the drum and the suds container regularly and if rust occurs, remove it immediately with a proprietary stainless steel care product.

Check the door seals for ferrous residues. Clean the door seals regularly as a preventive measure using proprietary care products.

Drum shaft bearings

Once the service interval has been reached, the following message appears in the display:

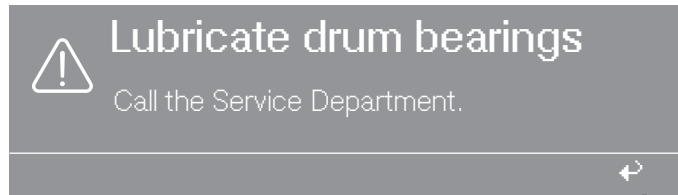





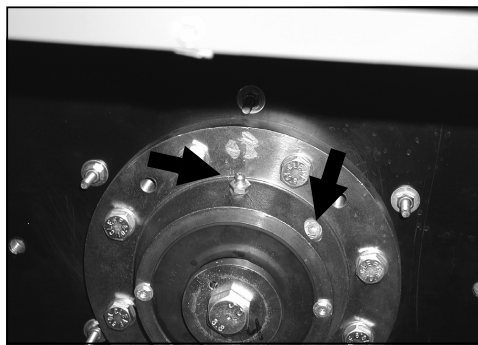













This message is removed by pressing the  button. It appears after switching on the machine until the service technician has performed this work.

 Disconnect the machine from the mains.



- Unscrew the bleed screw before greasing.
- Use grease nipples to lubricate the left and right drum bearings with Arcanol L 100 grease after approx. 1000 operating hours. While doing so, turn the drum three revolutions.
- Remove the old grease that has leaked out.

Meaning of the symbols on the data plate

Model	①				⑮		⑰ IBN	
SN:	②					⑯		
Art.-Nr.	③							
Mat.-Nr.	④				⑱		Total	Total
	⑤							
								
								
								
	⑥				⑳			
	⑦							
					㉑			
	\emptyset \leftrightarrow	⑨		Q_n (Hi) ㉒				
		⑩						
	Vol./G	⑪						
	E kin	⑫						
	0 \rightarrow \rightarrow	⑬ 1/min						
	\rightarrow \rightarrow \rightarrow 0	1/min						
					IP X4	㉓		

Model	
SN:	/ 00000000
Art.-Nr.	Mat.-Nr.
IBN	

- | | |
|----------------------------------|---|
| ① Model | ⑮ Ramp-up time |
| ② Serial number | ⑯ Braking time |
| ③ Item number | ⑰ Heating |
| ④ Material number | ⑱ Designation/year of construction |
| ⑤ Voltage/frequency | ⑰ Commissioning date |
| ⑥ Control fuse | ⑱ Electric heating |
| ⑦ Drive motor | ⑲ Fuse (on site) |
| ⑧ Drum data | ⑳ Indirect steam heating |
| ⑨ Drum diameter/drum depth | ㉑ Direct steam heating |
| ⑩ Spin speed | ㉒ Gas heating |
| ⑪ Drum volume/laundry dry weight | ㉓ Field for certification marks/identifiers |
| ⑫ Kinetic energy | |

Meaning of the symbols on the data plate

Airborne noise emission

A-weighted emission sound pressure level

PW 6163 70 dB (A)

PW 6243 71 dB (A)

PW 6323 71 dB (A)

max. in the workplace

EN ISO 11204

A-weighted sound power level

PW 6163 79 dB (A)

PW 6243 81 dB (A)

PW 6323 81 dB (A)

max. in the workplace

EN ISO 9614-2

Installing the washing machine

 Danger due to incorrect installation. Improper installation of the washing machine may result in injury and damage. The washing machine must be installed by Miele Customer Service Department or by an authorised dealer.

General operating conditions

This washing machine is intended only for use in a commercial environment and must only be operated indoors.

Ambient temperature in installation room: 0 °C to 40 °C

Relative humidity: non-condensing

Depending on the nature of the installation site, sound emissions and vibration may occur.

Tip: Have the installation site inspected and seek the advice of a professional in instances where increased noise may cause a nuisance.

Do not install in rooms which may be subject to very low temperatures

 Risk of damage due to frost. Frozen hoses are at risk of tearing or bursting. The reliability of the electronic module may be impaired at temperatures below freezing point. Do not install the washing machine in a room where there is a risk of frost.

Installing and mounting the washing machine

The washing machine must be level and securely installed. The washing machine must be secured to the floor after installation.

To secure the washing machine to the floor, you can drill through the existing holes in the base frame.

- Disassemble the two side panels.

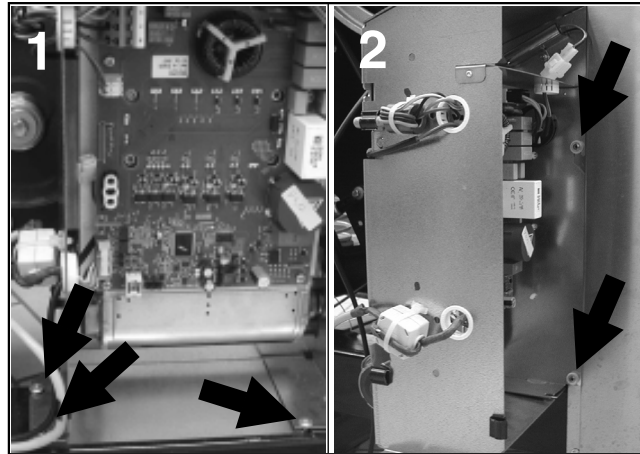

- Disassemble the casing of the frequency converter (1). The casing is attached with 3 screws.
- Hang the frequency converter at the side (2).

Disassembling the mounting bracket on steam-heated machines

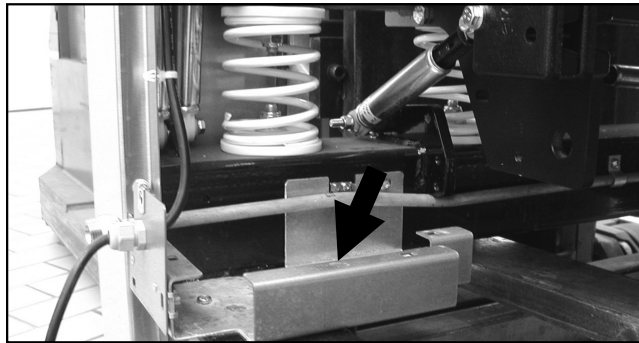

- On steam-heated washing machines, also disassemble the mounting bracket for the steam connection.
- Drill through the 4 existing holes on the base frame of the washing machine into the floor.

Do not place the washing machine on a carpeted floor if the carpet may block the ventilation openings on the bottom of the casing.

Removing the transit bars

The transit bars must only be removed at the installation site before the washing machine is commissioned.

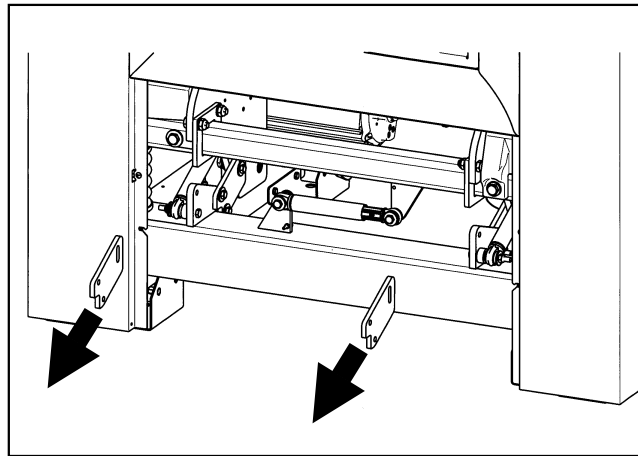

- Remove the 2 transit bars on the clean side of the washing machine.
- Remove the 2 transit bars on the unclean side of the washing machine.

Retain the transit bars. The transit bars will need to be reassembled should the washing machine ever need to be moved again.

Transporting the washing machine

⚠ Risk of injury from incorrect transport.
If the washing machine tips up there is a risk of serious injury to people and damage to property.
Make sure the washing machine is stable during transportation.

- Transport the washing machine on a pallet truck inside the room.
- Install the service panels supplied separately to the washing machine.
- Attach the protective conductor (green/yellow insulation).

Removing the transit bars on the weighing system

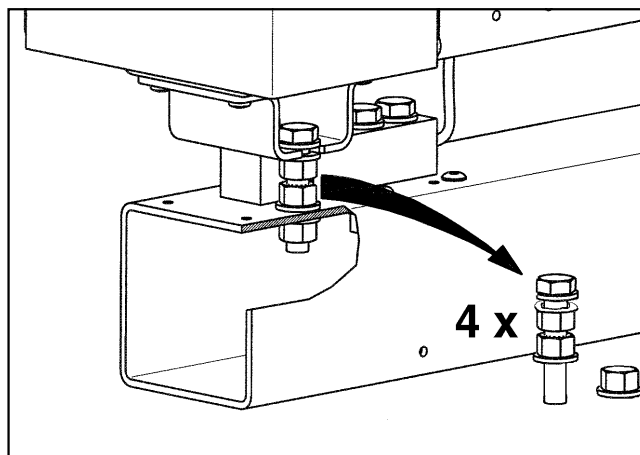

- Loosen the nuts on the 4 screws with an open spanner.
- Retain the transit bars. The transit bars will need to be reassembled should the washing machine ever need to be moved again.

Assembling the transit bars

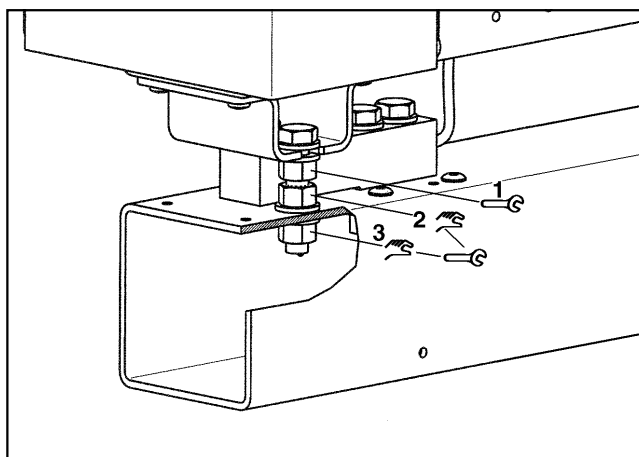

- Assemble the 4 screws and their 3 nuts by hand.
- Use an open spanner to tighten nut 1.
- Adjust nut 2 and 3 without tension by hand. Use an open spanner to tighten the nuts against each other.

Water connection

A water connection pressure of a minimum of 100 kPa (1 bar) and a maximum of 1000 kPa (10 bar) is required to guarantee problem-free operation.

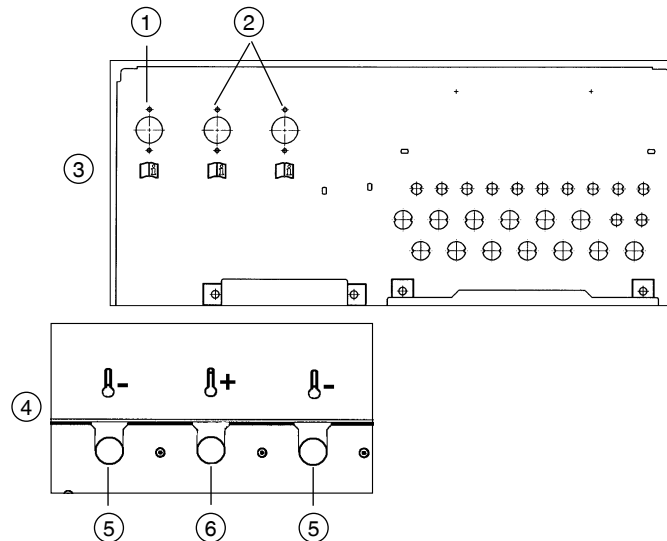

- ① Cold water for liquid dispensing
- ② Hard water (cold water)
- ③ Casing side
- ④ Casing lid
- ⑤ Cold water
- ⑥ Hot water

The connection to the supply line must be made via a water shut-off valve. This installation may only be carried out by an authorised installation technician in accordance with local and national regulations and regulations of the local water supplier.

The machine must be connected to the water supply using the water inlet hoses provided.

The hot water supply must not exceed a maximum temperature of 70 °C.

Hoses must be replaced with hoses tested for a burst pressure of at least 7000 kPa (70 bar) overpressure. The hoses must be suitable for a water temperature of at least 90 °C. The same requirements also apply to associated connection fittings. Miele original spare parts meet these requirements.

Use of non-return valves

In Germany, the machine must be connected to the water supply using the non-return valve provided.

According to national regulations for drinking water quality, with effect from 21 March 2021, a non-return valve to prevent backsiphoning must be installed between the stopcock and the water inlet hose during commissioning on all machines in Germany. The non-return valve prevents water from the water inlet hose from flowing back into the on-site drinking water supply.

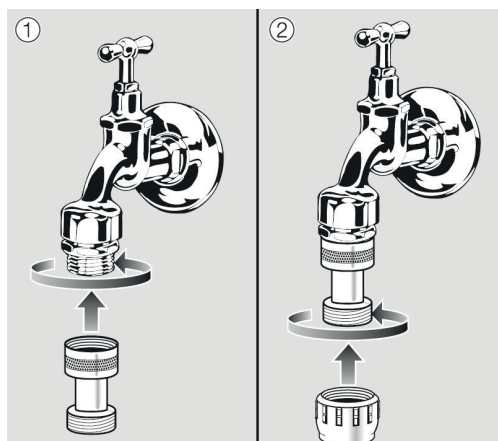

- Screw the non-return valve onto the stopcock.
- Screw the water inlet hose onto the thread of the non-return valve.

Regulations for Austria

Only pipes which comply with § 12 Section 1 of the 1960 Regulation on Execution of the Water Supply Act may be used to connect the machine with the installation location interior.

The use of rubber or plastic tubing as pressure connection piping between the installation location interior and the machine is only permitted if:

- in conjunction with connection fittings, it can withstand a minimum permanent pressure of 1500 kPa (15 bar),
- it is satisfactorily inspected during commissioning and
- after each use of the machine the water supply is reliably cut off before the rubber and plastic piping and put out of service or cut off from the location interior.

Detergent connections

You can connect up to 12 detergents to the washing machine.

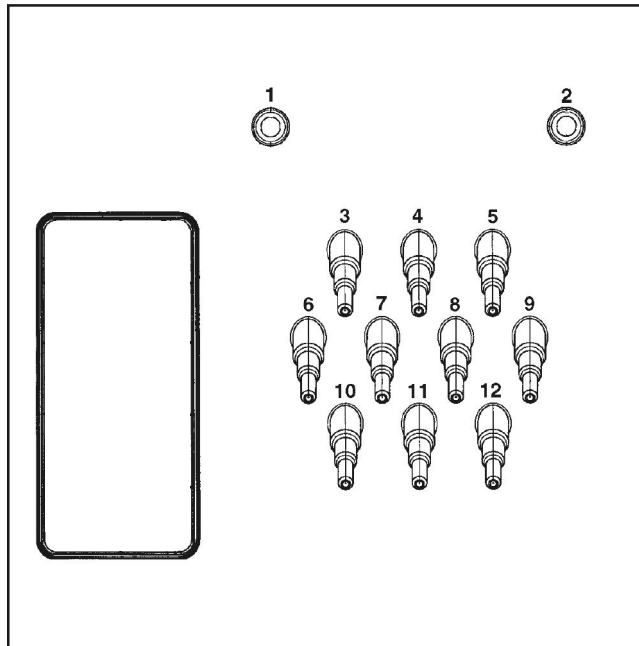

Detergent connections on the back panel of the machine

Use connections **1** and **2** for viscous agents or for high-pressure dispensing systems with water injection. The dispensing systems must be installed with a separate drinking water safety feature (in accordance with EN 61770 and EN 1717). The maximum flow rate is 1500 ml/min with a maximum water connection pressure of 300 kPa.

These connectors are sealed and need to be drilled open using an 8 mm drill bit before connecting.

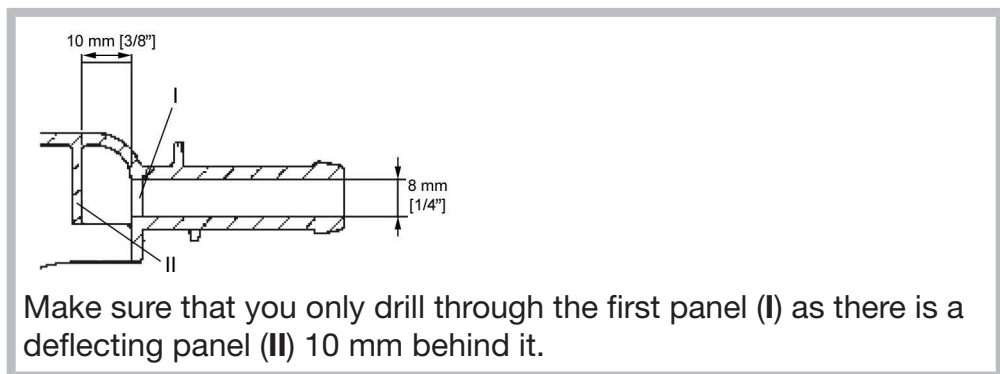

Make sure that you only drill through the first panel (I) as there is a deflecting panel (II) 10 mm behind it.

Connections **3** to **12** are provided for liquid detergent. High-pressure dispensing systems with water injection must not be connected to these connections. The connectors are sealed and must be cut to the diameter of the hose with a small saw before they are connected.

Connectors that are no longer required must be resealed using a suitable sealant (e.g. silicone).

Up to 4 time-controlled dispensing pumps can be operated without a multifunction module. Connection terminals are located behind the cover adjacent to the electrical connection. See enclosed wiring diagram.

Calibration of the dispensing pumps and regulation of dispensing quantities is carried out semi-automatically for washing machines fitted with an optional multifunction module.

A flowmeter or flow sensors can be connected for precise monitoring of the dispensing quantity.

Connections for level monitoring are available for every agent dispensed.

Electrical connection

The electrical connection must only be carried out by a qualified electrician who must ensure that all electrical work is carried out in accordance with applicable electrical regulations and standards (BS 7671 in the UK).

► This washing machine must be connected to an electrical mains supply that complies with local and national regulations. Please also observe the regulations set out by your insurance provider and energy supplier, accident prevention regulations, as well as recognised codes of practice.

► The required voltage, power rating and fusing rating can be found on the data plate on the washing machine. Before connecting the washing machine to the power supply, please ensure that the mains supply voltage complies with the values given on the data plate.

⚠ Damage caused by incorrect supply voltage.

Connection to a supply voltage other than the one quoted on the data plate can lead to functional faults and damage the washing machine.

Only connect the washing machine to the supply voltage specified on the data plate.

If more than one voltage is quoted on the data plate, the washing machine can be converted for connection to the voltages stated by the Miele Customer Service Department.

► Conversion to a different voltage must only be carried out by the Miele Customer Service Department or by an authorised dealer. The wiring instructions given on the provided wiring diagram must be followed.

The washing machine can either be hard-wired or connected using a plug-and-socket connection in accordance with IEC 60309-1. For a hard-wired connection, an all-pole means of deactivation must be installed on site.

If the power supply cannot be permanently disconnected, the means of deactivation must be safeguarded against being switched on either unintentionally or without authorisation.

Installation

Tip: It is recommended to connect the washing machine to the power supply via a plug and socket so that it is easier to conduct electrical safety checks (e.g. during maintenance).

► If it is necessary to install a residual current device (RCD) in accordance with local regulations, a residual current device type B (sensitive to universal current) must be used.

An existing type A residual current device (RCD) must be exchanged for a type B RCD.

The electrical components of the machine comply with DIN EN 60335-1, DIN EN 50571. The voltage is stated on the data plate. For hard-wired machines, an all-pole means of deactivation must be provided on site. Switches with a minimum contact gap greater than 3 mm are suitable disconnectors. These include circuit breakers, fuses and contactors (VDE 0660). The plug connector or disconnector must be easily accessible at all times.

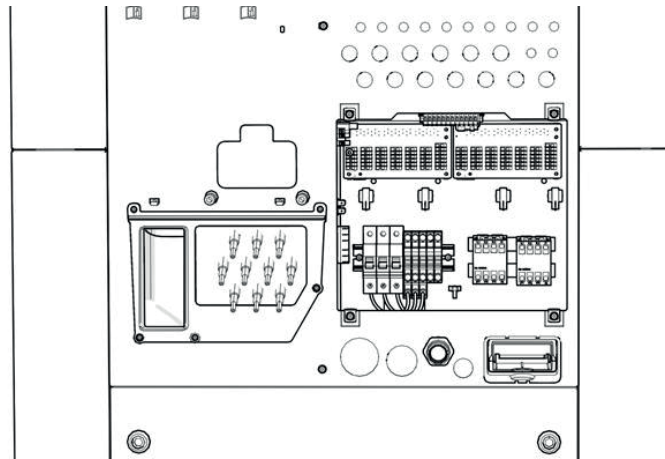

Exposed connection terminals after removing the cover

To gain access to the connection terminals, the cover over top of them must first be removed. The connecting cable must be routed through the toroidal core to the connection terminals.

The machine is supplied ex-works for 3N AC 50–60 Hz. The voltage is stated on the data plate.

Versions:

3 N AC 380–415 V 50–60 Hz

3 AC 220–240 V 50–60 Hz

Equipotential bonding

An equipotential bond with good contact connection must always be provided in accordance with all national and local regulations.

The electric heating is set ex-works to 15 kW (PW 6163), 24 kW (PW 6243), 30 kW (PW 6323).

The minimum liquor level to activate the heater is 70 mm water column.

The motor is protected against overload by winding protection.

Please refer to the wiring diagram and installation plan provided. These plans are important for the electrical connection.

Connecting the dispensing pumps

Connection terminals for 4 time-controlled dispensing pumps, which can be operated without a multifunction module, are located behind the cover adjacent to the electrical connection. See enclosed wiring diagram.

Steam connection

For steam-heated machine variants, the steam connection must only be carried out by an authorised installation technician. The steam valve and the condensate separator are available from the Miele Customer Service Department.

 Risk of electric shock and injury from live or rotating machine parts.

If the washing machine's casing is not fully assembled, it is possible to come into contact with live or rotating machine parts.

Once the washing machine has been installed, completely reassemble all the casing parts that were removed.

1. Preparing the laundry

Only machine wash items which have a wash care label stating that they are suitable for machine washing or for wet cleaning.

- Empty all pockets.



2. Switching on the machine and loading the laundry

- Switch on the washing machine with the **I** button.
- Pull the door handle to open the drum door.
- Unfold the laundry and load loosely into the drum. Mixing both large and small items gives better wash results and also helps to distribute the load evenly during spinning.
- Close the drum door by pressing it until the pre-latch engages.

3. Adding detergent

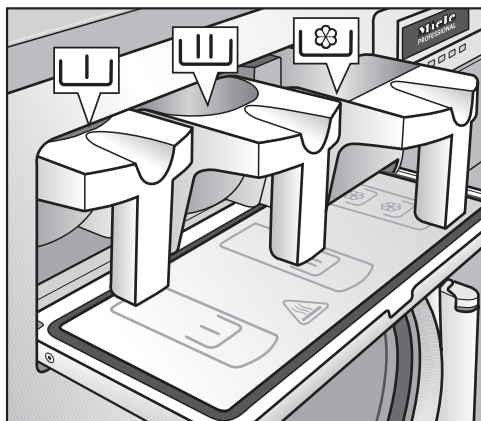
There are three separate drawers for adding detergent.



- Add powder detergent to the  drawer for the main wash.
- Add detergent for the pre-wash to the  drawer if necessary.
- Add fabric conditioner to the front  drawer if necessary.

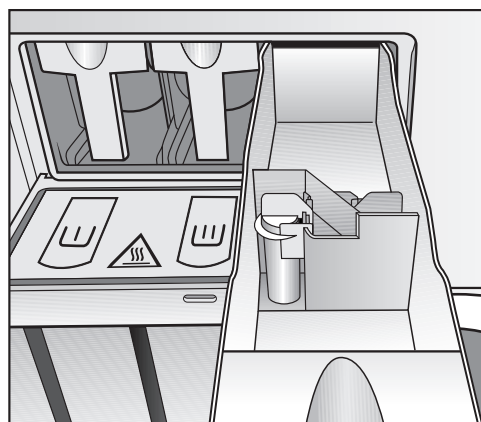

Liquid bleaching agents must only be dispensed through the designated  drawer.

4. Select a programme by rotating the rotary control

5. Press the “START” button to start the selected wash programme

If the message “Door lock error” appears, proceed as follows:

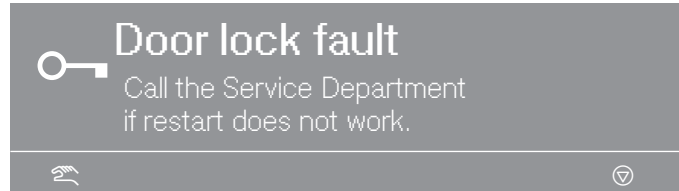

- Press firmly against the door handle until the door lock audibly engages.
- Press the “START” button.

6. The end of the programme is indicated in the display

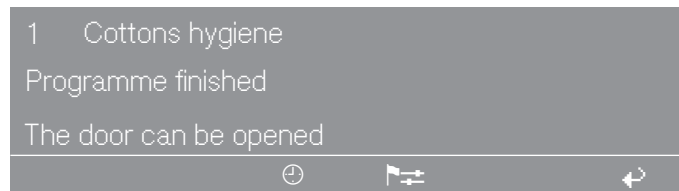

- Pull the door handle to open the drum door at the end of the programme.
- Remove the laundry.

7. If no further wash programmes are planned:

- Leave the drum door open.
- Switch off the machine with the 0 “Power off” button.

United Kingdom

Miele Co. Ltd., Fairacres, Marcham Road
Abingdon, Oxon, OX14 1TW
Professional Sales, Tel: 0845 365 6608
E-mail: professional@miele.co.uk
Internet: www.miele.co.uk/professional

Australia

Miele Australia Pty. Ltd.
ACN 005 635 398, ABN 96 005 635 398
Level 4, 141 Camberwell Road, Hawthorn East, VIC 3123
Tel: 1300 731 411
Internet: www.miele.com.au/professional
E-mail: sales@miele-professional.com.au

China Mainland

Miele Electrical Appliances Co., Ltd.
1-3 Floor, No. 82 Shi Men Yi Road
Jing' an District, 200040 Shanghai, PRC
Tel: +86 21 6157 3500, Fax: +86 21 6157 3511
E-mail: info@miele.cn, Internet: www.miele.cn

Hong Kong, China

Miele (Hong Kong) Ltd.
41/F - 4101, Manhattan Place
23 Wang Tai Road, Kowloon Bay, Hong Kong
Tel: (852) 2610 1025, Fax: (852) 3579 1404
Email: customerservices@miele.com.hk
Website: www.miele.hk

India

Miele India Pvt. Ltd.
1st Floor, Copia Corporate Suites,
Commercial Plot 9, Mathura Road, Jasola,
New Delhi - 110025
E-mail: customercare@miele.in, Website: www.miele.in

Ireland

Miele Ireland Ltd.
2024 Bianconi Ave., Citywest Business Campus, Dublin 24
Tel: (01) 461 07 10, Fax: (01) 461 07 97
E-Mail: info@miele.ie, Internet: www.miele.ie

Malaysia

Miele Sdn Bhd
Suite 12-2, Level 12
Menara Sapura Kencana Petroleum
Solaris Dutamas No. 1, Jalan Dutamas 1
50480 Kuala Lumpur, Malaysia
Phone: +603-6209-0288
Fax: +603-6205-3768

New Zealand

Miele New Zealand Limited
IRD 98 463 631
8 College Hill
Freemans Bay, Auckland 1011, NZ
Tel: 0800 464 353
Internet: www.miele.com.au/professional
E-mail: sales@miele-professional.com.au

Singapore

Miele Pte. Ltd.
29 Media Circle, #11-04 ALICE@Mediapolis
Singapore 138565
Tel: +65 6735 1191, Fax: +65 6735 1161
E-Mail: info@miele.com.sg
Internet: www.miele.sg

South Africa

Miele (Pty) Ltd
63 Peter Place, Bryanston 2194
P.O. Box 69434, Bryanston 2021
Tel: (011) 875 9000, Fax: (011) 875 9035
E-mail: info@miele.co.za
Internet: www.miele.co.za

United Arab Emirates

Miele Appliances Ltd.
Showroom 1, Eiffel 1 Building
Sheikh Zayed Road, Umm Al Sheif
P.O. Box 114782 - Dubai
Tel. +971 4 3044 999, Fax. +971 4 3418 852
800-MIELE (64353)
E-Mail: info@miele.ae, Website: www.miele.ae



Manufacturer: Miele & Cie. KG
Carl-Miele-Straße 29, 33332 Gütersloh, Germany