



## Operating and installation instructions Commercial washing machine PW 6241 PW 6321

---

To avoid the risk of accidents or damage to the machine, it is **essential** to read these instructions before it is installed and used for the first time.

en-GB

# Contents

---

<b>Warning and Safety instructions</b> .....	4
Explanation of the safety instructions and warnings on the machine.....	4
Intended use.....	5
Foreseeable misuse.....	6
Technical safety.....	8
Correct use.....	10
Chlorine and component damage.....	12
Accessories.....	13
Disposing of your old machine.....	13
<b>Caring for the environment</b> .....	14
<b>Description of the machine</b> .....	16
Machine description.....	16
Control panel.....	17
Function buttons.....	18
Programme card for the supervisor.....	19
<b>Washing</b> .....	20
Initial commissioning.....	20
Preparing the laundry.....	20
Emptying pockets.....	20
Load sizes.....	21
Washing with detergent drawers.....	22
Adding detergent using the detergent drawer.....	22
Bleaching agents.....	22
Dyes, dye removers and descalers.....	23
Detergent dispensing.....	23
Dispensing quantity.....	23
Water hardness levels.....	24
Selecting a programme.....	25
Selecting the Pre-wash, Starch stop or Without spin additional functions.....	25
Changes before starting the programme.....	26
Load size.....	26
Temperature.....	26
Spin speed.....	26
Maximum spin speeds.....	26
Starting the programme.....	26
Opening the drum door after the programme has finished.....	28
Procedure in the event of a programme interruption during operation.....	29
<b>Washing by card operation</b> .....	30
Card operation.....	30
Laundry load operation.....	31
<b>Additional functions</b> .....	32
Temporarily changing the language.....	32
Start time.....	33
Cancelling the start time.....	33
With pre-wash.....	34
Without spin.....	35
Programme stop.....	35
Programme cancellation.....	36

Cancelling a locked programme.....	36
Skipping a programme .....	37
<b>Optional modules</b> .....	38
Liquid dispensing (optional for machines with dispenser compartment).....	38
Deselecting dispensing .....	39
Amount to be dispensed .....	39
Commissioning the dispensing pumps .....	39
Dispenser calibration.....	40
Cleaning and maintenance of the dispensing system.....	41
Peak-load negotiation .....	41
Communication module .....	42
Operating data.....	42
Total data.....	44
Programme data.....	45
Delete data .....	47
Weighing system/weighing plinth.....	48
Resetting the load display to zero .....	48
<b>Problem solving guide</b> .....	49
The drum door cannot be opened .....	49
The safety catch of the door handle is disengaged .....	49
Power failure during the wash cycle; opening the door in an emergency.....	50
In the event of a brief power failure:.....	50
Possible reasons for increased levels of foaming .....	52
Service interval and DGUV display .....	53
Customer Service Department.....	56
<b>Cleaning and care</b> .....	57
Build-up of rust.....	57
Cleaning the detergent drawer, detergent compartments and siphons.....	58
Drum shaft bearings.....	60
Downtimes .....	60
<b>Meaning of the symbols on the data plate</b> .....	61
Sound emissions.....	61
<b>Installation</b> .....	62
Transit bars.....	62
Water connection .....	63
Water connections .....	63
Connection to the water inlet/drainage .....	63
Connection to the cold water supply .....	64
Use of non-return valves .....	64
Regulations for Austria .....	65
Dispensing agent connection to the mixer compartment .....	65
Electrical connection .....	67
Equipotential bonding .....	67
Connecting the dispensing pumps .....	68
Steam connection .....	68
<b>Quick Start Guide</b> .....	69

## Warning and Safety instructions

---

### Explanation of the safety instructions and warnings on the machine



Read the operating instructions



Read all the instructions, e.g. the installation instructions



Warning, hot surfaces



Warning, voltage up to 1000 volts



Earthing



Equipotential bonding

This washing machine complies with all current local and national safety requirements. However, inappropriate use can lead to personal injury and damage to property.

Read the operating instructions carefully before using the washing machine. They contain important information on safety, installation, use and maintenance. This prevents both personal injury and damage to the washing machine.

In accordance with standard IEC 60335-1, Miele expressly and strongly advises that you read and follow the instructions in the chapter on installing the washing machine as well as the safety instructions and warnings.

Miele cannot be held liable for damage caused by non-compliance with these instructions.

Keep these operating instructions in a safe place and pass them on to any future owner.

When instructing other people how to use the washing machine, they must be made aware of these safety and warning instructions.

### Intended use

- ▶ The washing machine is only suitable for washing fabrics with a care label stating that they are suitable for machine washing. Any other applications may be dangerous. The manufacturer cannot be held liable for damage resulting from incorrect or improper use or operation of the machine.
- ▶ This washing machine must be used as described in the operating instructions and must be checked on a regular basis to make sure it is functioning correctly. Maintenance must be carried out when necessary.
- ▶ The washing machine is not suitable for outdoor use.
- ▶ Do not install your washing machine in a room where temperatures below freezing may occur. Frozen hoses are at risk of tearing or bursting. The reliability of the electronic module may be impaired at temperatures below freezing point.
- ▶ This washing machine is intended only for use in a commercial environment.
- ▶ The washing machine must not be used in a non-stationary installation site (e.g. on a ship).
- ▶ This washing machine is only intended for items of laundry which have not been impregnated with dangerous or inflammable substances.
- ▶ For disinfection procedures, use temperatures, holding times, liquor ratios and, if necessary, disinfectants to achieve the required infection prophylaxis in accordance with guidelines and microbiological and hygienic standards.
- ▶ Disinfection programmes must not be interrupted, as this can have a limiting effect on the disinfection result. It is the operator's responsibility to ensure that the standard of disinfection in thermal as well as chemo thermal procedures is maintained by carrying out suitable validation tests.
- ▶ If the laundry has special result quality requirements, such as rinsing result, an absence of particles, wettability and liquid permeability, the procedure must be validated accordingly. The supervisor must guarantee the reprocessing standard with regular quality checks.
- ▶ Do not store or use petrol, paraffin or any easily flammable substances near the washing machine. There is a risk of fire and explosion.
- ▶ If the washing machine is operated in a publicly accessible place, it is the supervisor's responsibility to ensure that suitable measures are in place to protect users from any source of risk or danger.

## Warning and Safety instructions

---

- ▶ This washing machine can only be used by people with reduced physical, sensory or mental capabilities, or lack of experience or knowledge, if they are supervised whilst using it or have been shown how to use it in a safe way and understand and recognise the consequences of incorrect operation.
- ▶ Children under the age of 8 must not be allowed near the washing machine unless they are constantly supervised.
- ▶ Children over the age of 8 may only use the washing machine without supervision if its operation has been clearly explained to them and they are able to use it safely. Children must be able to understand and recognise the possible dangers caused by incorrect operation.
- ▶ Children may not carry out cleaning or maintenance on the washing machine unsupervised.
- ▶ Always supervise any children in the vicinity of the washing machine. Never allow children to play with the washing machine.
- ▶ Any uses other than those listed above are prohibited. The manufacturer accepts no liability in such cases.

### Foreseeable misuse

- ▶ Never use solvent based cleaning agents, e.g. those containing benzene, in this washing machine. Doing so may result in damage to component parts and create toxic steam and fumes. **Risk of fire and explosion!**
- ▶ When washing with high temperatures, remember that the porthole glass becomes hot. Do not let children touch it during a wash programme.

### Danger of burning!

- ▶ Close the drum door after each wash cycle. This will prevent:
  - Children climbing into the washing machine or hiding things in it.
  - Pets or other small animals climbing into the washing machine.
- ▶ Do not damage, remove or bypass the safety components or control elements of this washing machine.
- ▶ Machines with a damaged control panel, wires or cables must not be used until they have been repaired.
- ▶ The water generated during washing is suds and not drinking water. Drain the suds into a proper drainage system.
- ▶ Always make sure that the drum is stationary before reaching in to remove laundry. Reaching into a moving drum is extremely dangerous. Danger of injury.
- ▶ Be careful not to put your hands in the gap between door and frame when closing the drum door.

## Warning and Safety instructions

---

▶ If the detergent compartment drawer is open and any of the dispenser drawers are missing, there is a **danger of scalding from splashing water**.

Do not operate the machine if any of its components are missing.

▶ It is particularly important to observe manufacturer's instructions when using a combination of cleaning agents and special application products. Products must only be used for applications approved by the manufacturer to avoid any material damage or the occurrence of strong chemical reactions.

## Warning and Safety instructions

---

### Technical safety

- ▶ This washing machine must be installed by the Miele Customer Service Department or by an authorised dealer.
- ▶ Before setting up the washing machine, check it for any externally visible damage. Do not install or use a damaged washing machine.
- ▶ The electrical safety of this washing machine can only be guaranteed when correctly earthed. It is most important that this basic safety requirement is regularly tested, and where there is any doubt the on-site wiring system should be inspected by a qualified electrician. Miele cannot be held liable for the consequences of an inadequate earthing system (e.g. electric shock).
- ▶ Unauthorised repairs could result in unforeseen dangers for the user, for which the manufacturer cannot accept liability. Repairs should only be undertaken by a Miele approved service technician, otherwise any subsequent damage will not be covered by the guarantee.
- ▶ Do not make any alterations to the machine, unless authorised to do so by Miele.
- ▶ Disconnect the washing machine from the power supply in the event of a fault and for cleaning and maintenance. The washing machine is only electrically disconnected from the power supply when:
  - The plug of the washing machine is unplugged, or
  - The mains fuse is disconnected, or
  - The screw-in fuse has been completely removedSee also “Installation – Electrical connection”.
- ▶ Washing machines with a damaged control element or cable insulation must not be used until they have been repaired.
- ▶ Only operate the washing machine when all removable outer panels are in place so that it is impossible to touch an electrical component or moving part.
- ▶ In the event of a fault or for cleaning and maintenance purposes, the washing machine must be isolated from the electricity supply. It is only completely isolated when:
  - The plug of the washing machine is unplugged, or
  - The mains fuse is disconnected, or
  - The screw-in fuse has been completely removed
- ▶ See also “Installation – Electrical connection”.
- ▶ The plug for the washing machine must always be kept accessible so that the machine can be easily disconnected from the power supply.



## Warning and Safety instructions

---

- ▶ The washing machine may only be connected to the water supply using the set of hoses supplied with the machine. Old sets of hoses must not be re-used. Check the sets of hoses regularly for signs of wear. Change the sets of hoses in good time to avoid the risk of leaks and subsequent water damage.
- ▶ Faulty components must only be replaced by genuine Miele spare parts. Miele can only guarantee the safety standards of the appliance when Miele spare parts are used.
- ▶ The cause of any leaks must be dealt with before the washing machine is restarted. Disconnect the washing machine immediately if any water leaks out.
- ▶ Steam heating malfunctions can result in high temperatures at the door, the dispenser and inside the drum (in particular at the edge of the drum). There is a risk of slight burns.  
This only applies to machines with steam heating.
- ▶ All relevant national provisions and regulations (DGUV in Germany) relating to accident insurance are applicable to this machine. It is recommended to carry out testing in accordance with the regulatory framework described in DGUV100-500 /Chapter 2.6/ Section 4. The test book required for the documentation is available from Miele.
- ▶ Follow the instructions in “Installation”.
- ▶ If the machine is to be hard-wired, there must be a means of disconnecting all poles from the power supply. The mains switch must be close to the washing machine and be clearly identifiable, un-hindered and easily accessible at all times.
- ▶ If the machine’s mains connection cable has been damaged, it must be replaced by the manufacturer or a qualified specialist.
- ▶ The power supply must be disconnected when performing maintenance or replacing parts on the machine. If the plug needs to be disconnected from the socket, the operating personnel must ensure that the plug remains disconnected at all times.

## Warning and Safety instructions

---

### Correct use

- ▶ The maximum dry laundry weight is 24 kg for PW 6241 and 32 kg for PW 6321. See the “Programme chart” for the maximum recommended load sizes for individual programmes.
- ▶ Before using the washing machine for the first time, check that the transport safety devices have been removed (see “Installation – Removing the Transport safety devices”). During spinning, transport safety devices which are still in place may result in damage to both the washing machine and adjacent furniture or machines.
- ▶ Never try to open the drum door of the washing machine using force. The door can only be opened when a corresponding message appears in the display.
- ▶ When washing with high temperatures, remember that the porthole glass and drum door become hot. You must therefore keep children away from the porthole glass and drum door during the wash cycle.
- ▶ Close the drum door after each wash cycle. This will prevent:
  - Children climbing into the washing machine or hiding things in it.
  - Pets or other small animals climbing into the washing machine.
- ▶ Always close the drum door carefully. There is a risk of crushing and injury by shearing in the area around the hinges of the drum door.
- ▶ It must be possible to open the drum door fully. There must be no doors or other structural elements in the vicinity which prevent the drum door from opening.
- ▶ Always make sure that the drum is stationary before reaching in to remove laundry. Touching a moving drum poses a significant risk of injury.
- ▶ The procedures and machines listed here are not medical devices. Observe the programme descriptions and procedural information in the programme chart.
- ▶ Laundry is only disinfected in programmes with a disinfection step. All other programmes do not have a disinfection step (see the “Hygiene” programme chart). If laundry that has not been disinfected is transferred to the “clean” side of the washing machine, germ transfer or contamination may occur. The transfer of non-disinfected laundry to the “clean” side is the sole responsibility of the supervisor.
- ▶ This washing machine may only be operated without supervision if there is a floor drain (gully) in the direct vicinity of the washing machine.

## Warning and Safety instructions

---

▶ Disinfectants and detergents often contain chlorine-containing compounds. When agents containing chlorine dry on stainless steel surfaces, the resulting chlorides can attack the stainless steel and produce rust. Protect your washing machine from rust damage by using chlorine-free agents to wash, disinfect and clean the stainless steel surface. If in doubt, have the manufacturer confirm the suitability of the agent.

If agents containing chlorine get onto the stainless steel surface, clean the stainless steel surface immediately with water. Then use a cloth to dry the stainless steel surface.

▶ It is particularly important to observe manufacturer's instructions when using a combination of cleaning agents and special application products. Agents must only be used for applications approved by the manufacturer to avoid any material damage or the occurrence of strong chemical reactions. Confirmation must be sought from the manufacturer that using the agent in the washing machine will not cause damage.

▶ If the correct amount of detergent is dispensed, the machine should not need to be descaled. If, however, you do wish to descale it, only use proprietary non-corrosive descaling agents and strictly observe the instructions on the packaging. Special descaling agent is available from Miele. Strictly observe the instructions for the descaling agent.

▶ Close the stopcock if the machine is to be left for any length of time (e.g. while on holiday), especially if there is no floor drain (gully) in the immediate vicinity.

▶ Take care to ensure that foreign objects (e.g. nails, pins, coins, paper clips) do not find their way into the machine with the laundry. Foreign objects may damage components of the machine (e.g. suds container, drum). Damaged components can damage the laundry.

▶ Textiles which have been pre-treated in solvent-based cleaning agents must be rinsed in clean water before being washed in the machine. Note that solvent residues may only be discharged into waste water in compliance with local legislation.

▶ Never use solvent based cleaning agents, e.g. those containing benzene in this machine. Doing so may result in damage to component parts and create toxic fumes. **Risk of fire and explosion!**

▶ Do not store chemicals (liquid detergents, additives) on the machine lid. They may cause discolouration or lacquer damage. Accidentally spilled chemicals should be removed immediately with a wet cloth from the surface.

▶ There is a fan outlet on the back of the machine. Under no circumstances must this be blocked. Please observe the minimum distance on the installation diagram.

## Warning and Safety instructions

---

- ▶ Recommending chemical cleaning agents does not mean that the machine manufacturer is responsible for the influences of these agents on the laundry and the washing machine. Please note that undisclosed product changes by the manufacturers of these agents may affect the quality of the wash result.
- ▶ Only use dyes, dye removers and descalers suitable for use in a washing machine. The manufacturer's instructions on the packaging must be observed.
- ▶ Colour run and dye removers contain sulphur compounds which can cause damage such as corrosion. Do not use these products in this machine.
- ▶ Check the wash result of laundry contaminated with biological oils or greases. Inadequately washed laundry can cause spontaneous combustion during the drying process. Use special detergents or wash programmes for this kind of laundry.
- ▶ Do not use a pressure washer or hose to clean the washing machine.

### **Chlorine and component damage**

- ▶ Frequent use of chlorine products increases the risk of damage to components.
- ▶ The use of substances containing chlorine, such as sodium hypochlorite and chlorine bleach in powder form, can however result in damage of the protective layer of stainless steel and corrosion on components. Therefore, refrain from using substances containing chlorine. Use oxygen-based bleaching agents instead.

If, however, chlorine bleaching agents are used, an anti-chlorine treatment must always be carried out. Otherwise, both the washing machine components and the laundry may suffer persistent and irreparable damage.

- ▶ Anti-chlorine treatment must be carried out immediately after chlorine bleaching agents have been used. Hydrogen peroxide as well as oxygen-based detergents and bleaching agents are suitable for anti-chlorine treatment. The suds must not be drained in between.

Treatments with thiosulphates can result in gypsum-like deposits particularly when used in combination with hard water. This gypsum can build up in the washing machine or cause incrustations on the laundry. Treatment with hydrogen peroxide is recommended over treatment with thiosulphates because hydrogen peroxide neutralises chlorine.

The exact dispensing quantities and the treatment temperatures required must be set and tested on site in accordance with the dispensing recommendations of the detergent and cleaning agent manufacturers. The laundry must also be tested to check whether it contains any active chlorine residues.

### **Accessories**

▶ Accessory parts may only be fitted when expressly approved by Miele. If other parts are used, guarantee, performance and product liability claims will be invalidated.

Miele cannot be held liable for damage caused by non-compliance with these Warning and Safety instructions.

### **Disposing of your old machine**

▶ Ensure that the door locks are unusable when disposing of or scrapping old washing machines. This will prevent the risk of children playing accidentally locking themselves in and endangering their lives.

## Caring for the environment

---

### Disposal of the packing material

The packaging is designed to protect against transportation damage. The packaging materials used are selected from materials which are environmentally friendly for disposal and should be recycled.

Recycling the packaging reduces the use of raw materials in the manufacturing process and also reduces the amount of waste in landfill sites. Your dealer will take the packaging materials away.

### Disposing of your old appliance

Electrical and electronic appliances often contain valuable materials. They also contain specific materials, compounds and components, which were essential for their correct function and safety. These could be hazardous to human health and to the environment if disposed of with your domestic waste or if handled incorrectly. Please do not, therefore, dispose of your old appliance with your household waste.

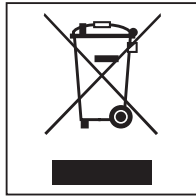

Please dispose of it at your local community waste collection / recycling centre for electrical and electronic appliances, or contact your dealer or Miele for advice. You are also responsible (by law, depending on country) for deleting any personal data that may be stored on the appliance being disposed of. Please ensure that your old appliance poses no risk to children while being stored prior to disposal.

### Energy saving tips

- Energy and water consumption** - To get the most out of your machine, load the **maximum** dry load size for the wash programme you are using.  
Energy and water consumption is most efficient when a full load is washed.
- Detergent**
- Do not exceed the amounts of detergent recommended by the manufacturer on the packaging.
  - Reduce the amount of detergent for smaller load sizes.
- When drying with a tumble dryer** Select the highest possible spin speed for the wash programme to save energy in the subsequent tumble dryer cycle.

## Description of the machine

---

### Machine description

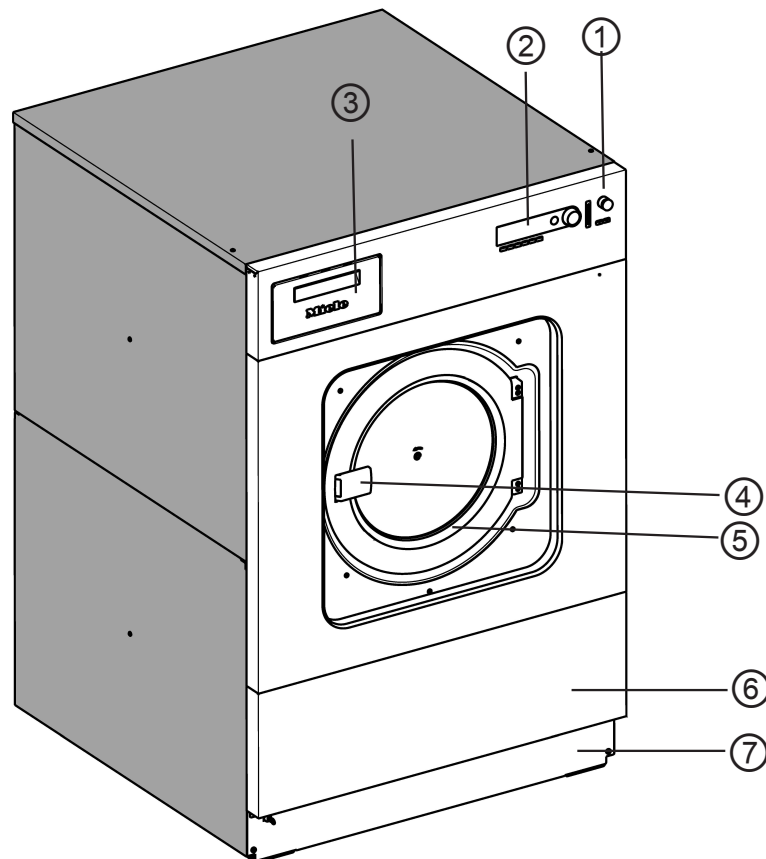

① **Emergency-off button**

Pressing the red button switches the machine off.

② **Control panel**

③ **Detergent drawer**

Pull the handle to open the flap.

④ **Door handle**

The door handle is equipped with an anti-snap mechanism to ensure the safety function of the door lock.

⑤ **Drum door**

Pull the door handle to open the drum door. Never use force to open the drum door.

⑥ **Service panel**

⑦ **Plinth panel**



## Control panel



### ① Display

1	Cottons hygiene	90 °C
2	Cottons universal	60 °C
3	Cottons intensive	60 °C

When the machine is switched on the welcome screen will appear briefly, followed by the programme list. The last started programme is highlighted.

### ② Function buttons

The six buttons underneath the display are the function buttons. These buttons can be allocated specific functions depending on the status of the machine. These functions appear in the display above the buttons and are highlighted when selected. By reprogramming “Direct button allocation”, the first six programmes in the programme list can be selected using buttons 1–6.

### ③ Start button

The light ring around the button flashes when a selected programme is ready to start. The selected programme starts when the start button is pressed. After a programme has been started, the display content can be shown again by pressing this button.

### ④ PC optical interface

Using PC software, data can be transmitted to and from the controls to a PC. The optical interface on the control panel provides the connection point.

### ⑤ Rotary control

Rotating the outer ring allows changes to be made to the display selection and input fields and also confirms these changes.

### ⑥ Card reader

When a card is inserted, the wash programmes on the card can be used. Insert the card in the direction of the arrow.

### ⑦ I Power on button

Switch on the machine

### ⑧ 0 Power off button

Switch off the machine

### ⑨ Emergency-off button

Only use in case of danger. Pressing the red button switches the machine off. When the hazard has been removed, the button can be unlocked by turning it clockwise. When the “START” button is pressed again, the interrupted programme continues.

# Description of the machine

---

## Function buttons

A function is activated when pressed and deactivated when pressed again.

### **Stop/finish**

The right-hand function button is used as the finish button after a programme has started. Pressing the button stops the selected programme or finishes a stopped programme.

### **Block+**

The corresponding programme block (e.g. Pre-wash) is added to the programme.

### **Starch stop**

Press this button if the laundry is to be starched.

### **Without spin**

Press this button if a final spin is not required after the final rinse.

### **Settings**

Another language can be temporarily selected by pressing this button.

### **Start date and time**

When this button is pressed before starting the programme, information about selecting a start time will appear in the display.

## **i Information**

Programme information appears in the display when this button is pressed.

### **Water drainage**

### **Manual control**

See programming instructions

### **Change order**

The current programme can be skipped or programme blocks can be repeated.

### **Back**

Return to previous display page.

### **Information on next/previous line**

### **Saving**

See programming instructions

### **Programme locked**

If a programme is locked, after 1 minute it can no longer be stopped and cancelled with the finish button.

### **Programme unlocked**

### **Dispensing**

### **Dispensing switched off**

### **Operating data**

### **Resetting to 0 (taring)**

If the load display does not show “00.0” with an empty drum, this can be rectified by pressing this button.

### **Data transfer**

### Programme card for the supervisor

There are no programmes on this card ex works. Please refer to the programming instructions for information on how data is transferred from the controls to the card.

If a card with saved programmes is placed in the card reader before the programme is started, the controls no longer access the internal programme memory. The content of the card is read and shown in the display as a programme list with the indication Card operation.

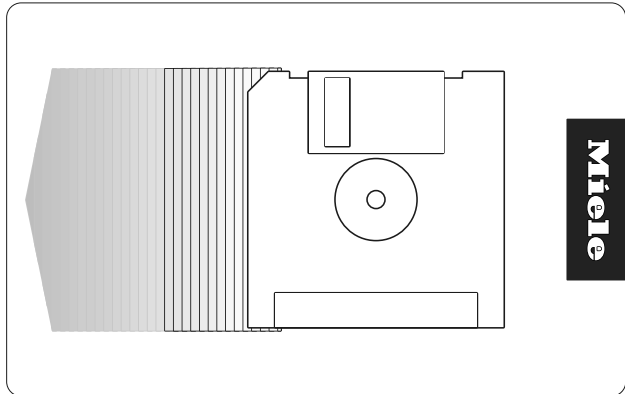

The card can hold a maximum of 30 programmes consisting of 6 blocks each. The back of the card can be labelled.

## Initial commissioning

⚠ The washing machine must be commissioned by the Customer Service Department or an authorised dealer.

- Open the on-site shut-off valves for water and/or steam.
- Switch on the (on-site) power switch.
- Switch the machine on with the **I** “Power on” button.



The welcome screen will appear in the display,

1	Cottons hygiene	90 °C
2	Cottons universal	60 °C
3	Cottons intensive	60 °C

Below the table, there are three navigation icons: a left-pointing arrow, a right-pointing arrow with a plus sign, and a right-pointing arrow with a minus sign.

followed by the programme list (the last started programme is highlighted).

Rotate the rotary control to select a programme and press the “START” button to start it immediately.

## Preparing the laundry

### Emptying pockets

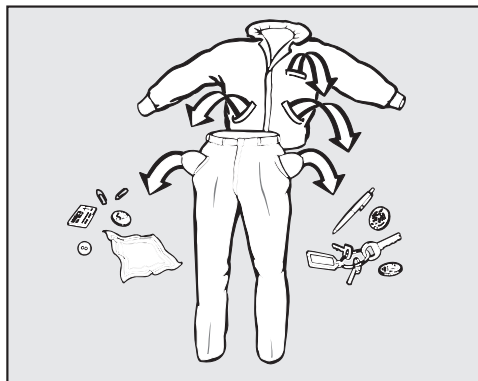

- Empty all pockets.

⚠ Damage due to foreign objects.  
Nails, coins, paper clips, and so on can cause damage to garments and components in the machine.  
Check the laundry before washing and remove any foreign objects.

## Load sizes

(dry laundry)

	PW 6241	PW 6321
<b>1</b> Cottons 90 °C		
<b>2</b> Cottons 60 °C		
<b>3</b> Cottons 60 °C Intensive	max. 24 kg	max. 32 kg
<b>4</b> Cottons 30 °C		
<b>5</b> Cottons 30 °C Intensive		
<b>6</b> Cottons Eco short		
<b>7</b> Minimum iron 60 °C		
<b>8</b> Minimum iron 60 °C intensive	max. 12 kg	max. 16 kg
<b>9</b> Minimum iron 30 °C		
<b>10</b> Minimum iron 30 °C intensive		
<b>11</b> Delicates		
<b>12</b> Woollens 30 °C	max. 9.6 kg	max. 12.8 kg
<b>13</b> Hand-washable woollens 30 °C		

Maximum load weights of other programmes are specified in the programme chart.



- Load the laundry.
- Close the drum door using the door handle; do not slam shut.

Make sure that no items are caught between the drum door and the opening.

## Washing with detergent drawers

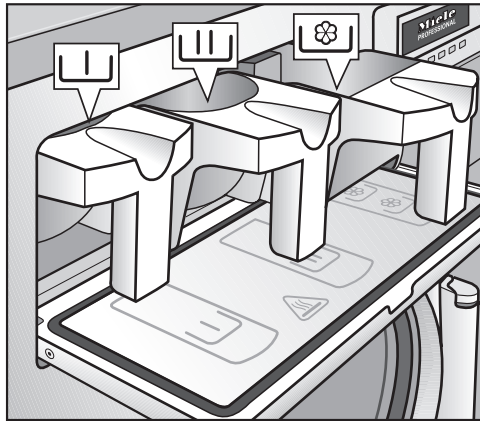
### Adding detergent using the detergent drawer



- For standard wash programmes add the powder detergent for the main wash to the  drawer and if desired, add detergent for a pre-wash to the  drawer. Add fabric conditioner to the front of the  drawer.

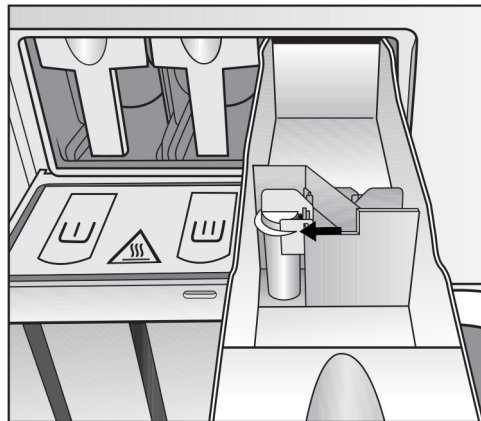

- Add any other detergent additives to the back of the  drawer (if this has been programmed).

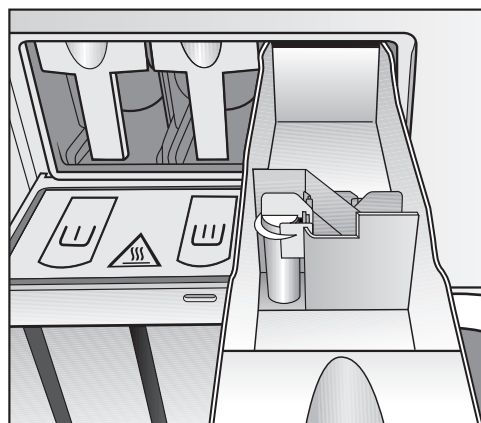

Do not fill the  drawers above the level marker with detergent additives.  
Otherwise they will run straight through the siphon into the suds container.

## Bleaching agents

Only use bleaching agents on fabrics with the  $\Delta$  symbol on the wash care label.

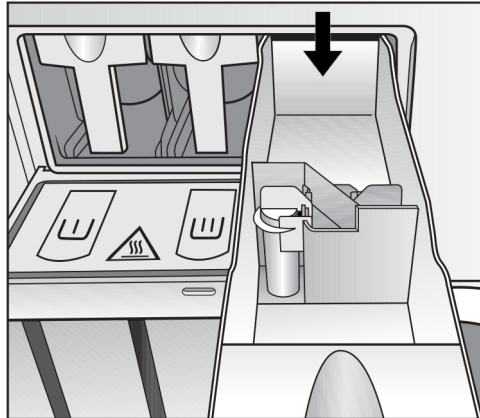

Liquid bleaching agents must only be dispensed through the designated dispenser drawer. The agent will then be dispensed automatically during the second rinse. Liquid bleaching agents should only be used on coloured items which have a wash care label stating that they are colour fast and suitable for bleaching.

 Frequent use of chlorine products increases the risk of damage to components.

## Dyes, dye removers and descalers

Proprietary dyes, dye removers and descalers may only be used in this washing machine if the manufacturer expressly states that they are suitable for use in a washing machine. The manufacturer's instructions on the packaging must be observed.

## Detergent dispensing

Avoid dispensing more than the required amount as this can cause excessive foaming.

- Only use low foaming detergents.
- Dispense according to the detergent manufacturer's recommendations.

The dispensing amount will depend on:

- The amount of laundry
- The water hardness
- The degree of soiling of the laundry

## Dispensing quantity

Please dispense according to water hardness levels and follow the detergent manufacturer's instructions.

## Washing

---

### Water hardness levels

Water hardness level	Water properties	Total hardness in mmol/l	German scale °d
I	Soft	0–1.3	0–7
II	Medium	1.3–2.5	7–14
III	Hard	2.5–3.8	14–21
IV	Very hard	Above 3.8	Above 21

Check with your local water supplier if you do not know the water hardness level in your area.



## Selecting a programme

- Select a programme by rotating the rotary control (e.g. Programme 1 Cottons).

The following (for example) will appear in the display:

18	Separate drain	
1	Cottons hygiene	90°C
2	Cottons universal	60°C

## Selecting the Pre-wash, Starch stop or Without spin additional functions

- Confirm the selected programme by pressing the inner button on the rotary control.

The following (for example) will appear in the display:

1	Cottons hygiene	24,0 / 24,0 kg
90°C	Main wash	
	Rinses	1100 rpm

- If required, add the “Pre-wash” programme block by pressing the + “Block+” function button.

When the + “Block+” function button is pressed, the following appears in the display:

1	Cottons hygiene	24,0 / 24,0 kg
40°C	Pre-wash	
90°C	Main wash	1100 rpm

The “+ ” field is highlighted.

The function can be deselected by pressing the button again.

Press the “Starch stop” button if the laundry is to be starched.

Press the “Without spin” button if a final spin is not required after the final rinse.

If you do not want to make any further changes to the programme:

- Press the “START” button to start the wash programme.

# Washing

## Changes before starting the programme

Changes can be made before the start of the programme, e.g. load, temperature or spin speed:

### Load size

The load size can be entered manually before the start of the programme.

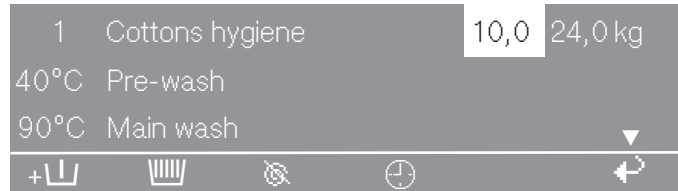

- Rotate the rotary control to select the “Load size” entry field and press the rotary control to confirm the selection.
- Rotate the rotary control to change the load size and press the rotary control to confirm the set value.

### Temperature

Before the programme starts, the temperature can be set in 1 °C increments from cold 15 °C to the max. 95 °C.

- Rotate the rotary control to select the “Temperature” field (e.g. 40 °C for the pre-wash) and press the rotary control to confirm the selection.

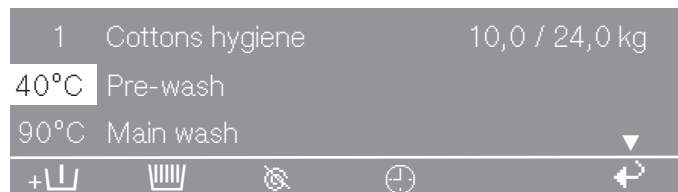

- Rotate the rotary control to change the temperature and press the rotary control to confirm the set value.

### Spin speed

in 25 rpm increments from 0, 300 up to a maximum of 1100 rpm (PW 6241) or 1000 rpm (PW 6321).

- Rotate the rotary control to select the “Spin speed” field (1000 rpm for the final spin) and press the rotary control to confirm the selection.

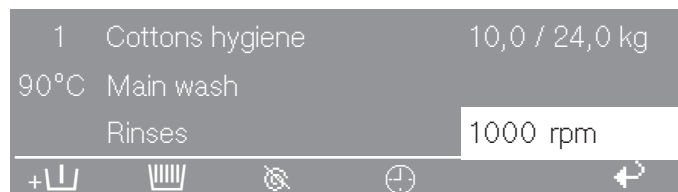

- Rotate the rotary control to change the spin speed and press the rotary control to confirm the setting.

### Maximum spin speeds

	PW 6241	PW 6321
	1100 rpm	1000 rpm

Press the “START” button to start the wash programme.

## Starting the programme

- Press the “START” button.

The wash programme will start.

After the programme has started, the programme sequence is shown in the display.



In the second line of the display, in this case Pre-wash, the current suds temperature is shown.



If the Pre-wash programme block is finished, the Main wash programme block will appear in the second line of the display with the current suds temperature. The next programme block, in this case Rinses 1, is shown below.

**Tip:** The programme finished display on the right shows the time that the programme will finish.

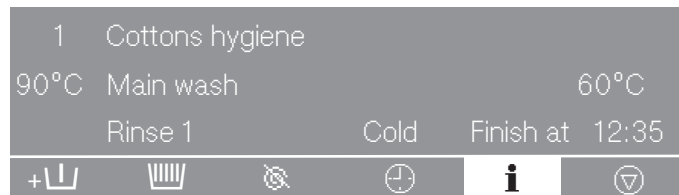

- Press the **i** “Information” button.

Further information about the wash programme will appear in the display. For example:

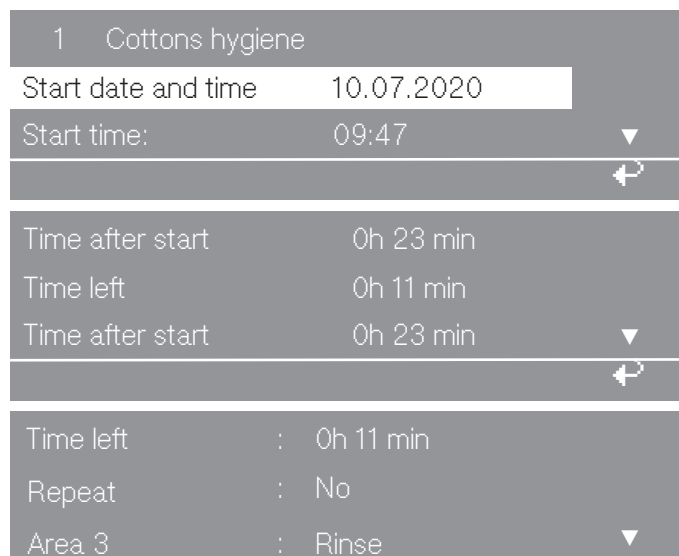

## Washing

Block 2	:	2nd rinse
Programme step	:	Wash time 1
Actual level	:	22 mm ▼
Required level	:	60 mm
Actual temperature	:	35 °C
Rqrd.	:	60 °C ▼
1	Cottons hygiene	
rpm:	40 rpm	
Rhythm	:	12 / 3 ▲
↶		

- Press the  “Back” button.

The display will automatically revert to the programme sequence.

### Opening the drum door after the programme has finished

At the end of the programme, when the drum has stopped rotating and no water is left in the machine, the following (for example) appears in the display:

1	Cottons hygiene	
Programme finished		
The door can be opened		
⊕    🚪    ↶		

At the same time, a buzzer sounds for 5 seconds at the end of the programme.

- Pull the handle to open the drum door.
- Pull the door handle to open the drum door.

Never use force to open the drum door!  
If the drum door cannot be opened, press against the drum door and then pull the door handle again.

- Remove the laundry.

## Procedure in the event of a programme interruption during operation

If the programme has been cancelled while there is still water in the machine or during spinning, the following will appear in the display (for example):

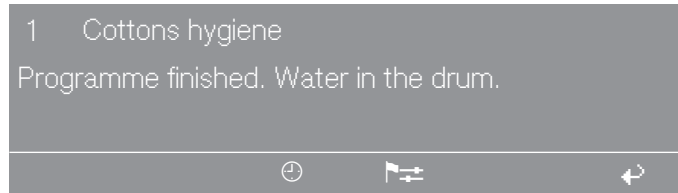

or

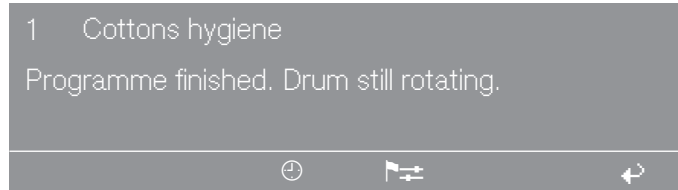

The drum door is locked.  
Do not attempt to open the drum door using force.

- Press the  “Water drainage” function button or select the “Separate spin” programme and press the “START” button.
- Open the door at the end of the programme.

If no further wash programmes are planned:

- Switch off the machine with the 0 “Power off” button.
- Switch the machine off with the (on-site) power switch.
- Close the on-site shut-off valves for water and steam.

## Washing by card operation

### Card operation

Cards with **at least one** programme are intended for a particular model of machine. Blank cards can be used in any machine.

- Switch on the machine with the **I** “Power on” button.

The welcome screen will appear in the display.

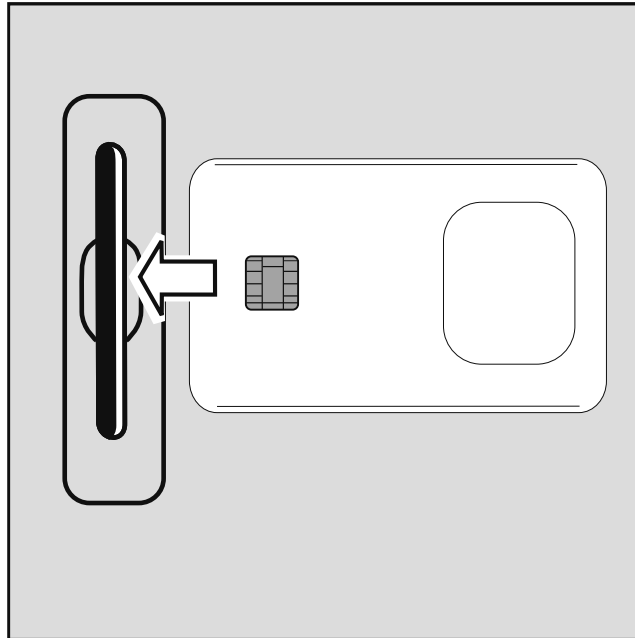

- Insert the card.

The programmes on the card will appear in the display.

Card operation		
17	Masks	45 °C
18	Minimum iron	60 °C

- Select a programme by rotating the rotary control. Press the rotary control to select the programme.
- Press the rotary control to select the highlighted programme.
- Press the “START” button.

The programme will start running.

Once the “START” button has been pressed, the card can be removed from the card reader. The programme will be deleted at the end of the programme.

**Do not insert any objects other than the card into the card slot.**

If the card is inserted into the slot the wrong way, the following message will appear in the display:

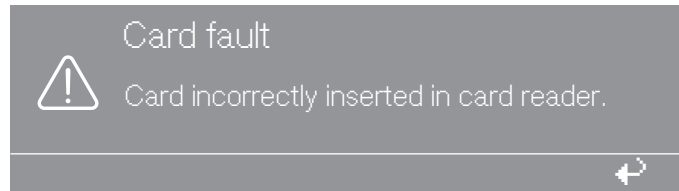

- Insert the card into the card reader correctly.

If the card is not suitable for this model of machine, the following message will appear in the display:

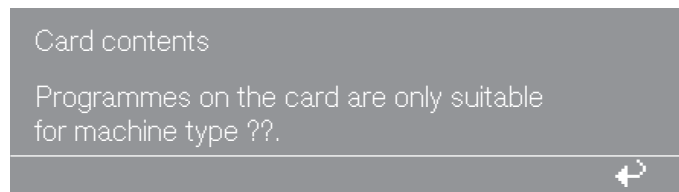

- Insert a suitable card for the model of machine.

### Laundry load operation

Laundry loads that require a special wash programme are assigned a programme card containing only the programme designed for the specific laundry load.

Laundry load operation can be activated via the **Card access** menu option in the supervisor level.

When the **Card access** menu option is activated, the controls will only accept cards that contain a laundry load programme. The programmes saved on the machine can no longer be accessed.

## Additional functions

### Temporarily changing the language

The display language can be changed temporarily via the flag symbol before starting the programme.

The language selected is reset 5 minutes after the end of the programme when the door is opened.

1	Cottons hygiene	90°C
2	Cottons universal	60°C
3	Cottons intensive	60°C
		

- Press the  function button.

The following appears in the display:

Settings	Back 
Main menu	Language 
Supervisor level	
	
	

- Press the rotary control to confirm the Language menu option.

Settings	dansk
Language 	english (GB)
english	
	
	

- Rotate the rotary control to select the desired language.

The selected language is highlighted.

- Press the rotary control to confirm the new display language.

The display is now shown in the newly selected language.



### Start time

A later wash start time can be allocated to a programme using the ⌚ “Start time” function button.

Setting a start time ■ Select the wash programme.

When a programme has been selected, the following (for example) will appear in the display:

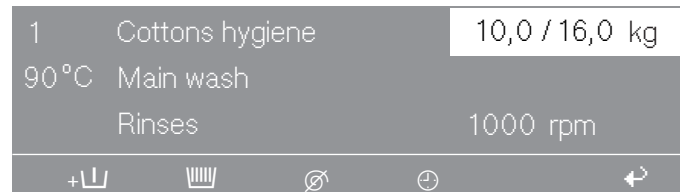

■ Press the ⌚ “Start time” function button.

The following (for example) will appear in the display:

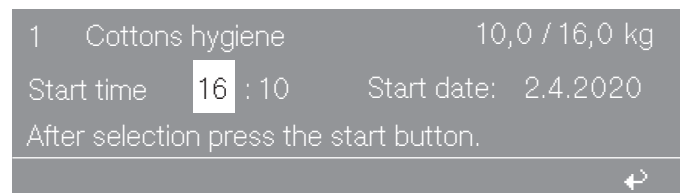

The current time and date always appear. The entry field for hours is highlighted.

- Press the rotary control to select the hour. Rotate the rotary control to change the hour and press the rotary control to confirm.
- Rotate the rotary control to select and confirm the “Minutes” field. Rotate the rotary control to change the minutes and press to confirm.
- Rotate the rotary control to select and confirm the “Start date day” entry field. Rotate the rotary control to change the day and press to confirm.
- Change the month and year if required.
- After setting the start time, press the “START” button and the programme will start at the set time.

The display shows the current time and date and the start time.

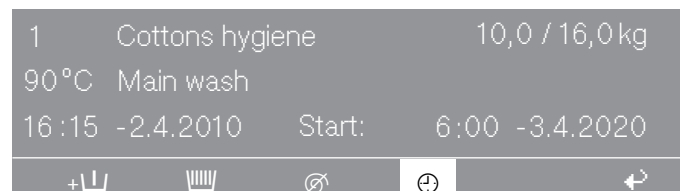

If the drum door is opened again, the “START” button must be pressed again.

### Cancelling the start time

■ Press the ⌚ “Start date and time” button or the ↶ “Back” button.

The changes will not be saved.

## Additional functions

### With pre-wash

A Pre-wash can be added for heavily soiled laundry before the programme has started in the standard programmes 1 to 10.

- Press the + “Block+” button.

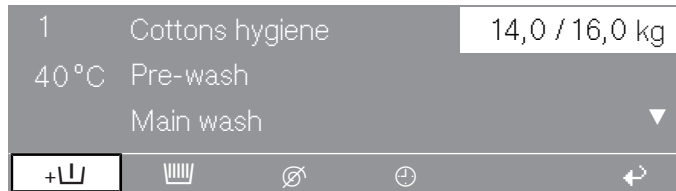

The following will appear in the display:



The “+” field is highlighted in the display.

**Tip:** The function can be deselected by pressing the + “Block+” button again.

### Adding via the drawer

Starching can be selected before the programme starts in all standard programmes (excluding Separate spin and Separate drain) by pressing the  “Starch stop” button. The  field will be highlighted in the display.

The function can be deselected by pressing the button again.

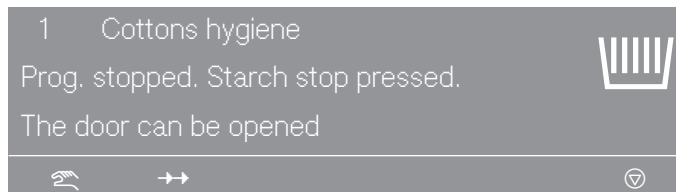

When the “Starch stop” programme stage is reached, Prog. stopped. Starch stop pressed. will flash in the display.

Prepare the starch according to the manufacturer’s instructions and add to the inflowing water via the front  drawer. Dilute the starch with water if necessary. The wash time will be automatically extended by 4 minutes.

The programme will continue when the “START” button is pressed.

### Adding directly into the drum

When the “Starch stop” programme stage is reached, open the drum door and add the starch prepared according to the manufacturer’s instructions. Close the drum door.

The following message appears in the display:

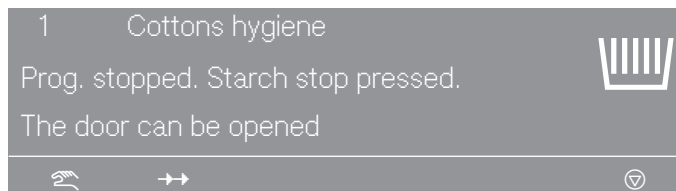

Press the “START” button and the programme will continue.

### Without spin

“Without spin”  can be selected before the programme starts in all standard programmes (excluding Separate spin).

- Press the “Without spin” button.

The  field will be highlighted in the display.

**Tip:** The function can be deselected by pressing the button again.

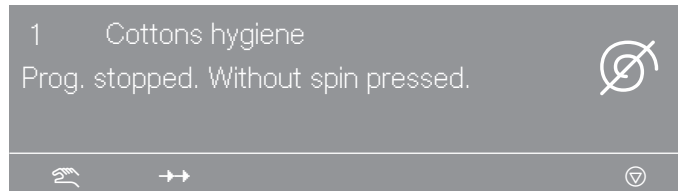

When the “Without spin” programme stage is reached, Prog. stopped. Without spin pressed. will flash in the display.

- End the programme without a spin and with Water in the machine by pressing the  “Stop/finish” button.

**Tip:** The programme can be continued with a spin by pressing the “Start” button.

### Programme stop

Stopping the programme.

- Press the  “Stop/finish” button to stop the programme.

The programme is stopped.

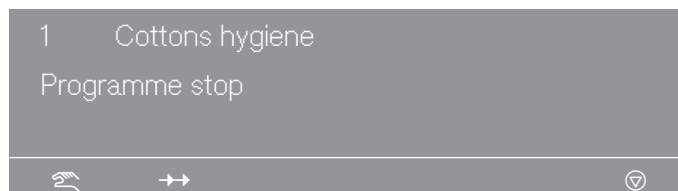

**Tip:** The programme can be continued by pressing the “START” button.

### Programme cancellation

The programme can be cancelled as follows.

- Press the  “Stop/finish” button twice in succession.

The programme is cancelled.

If the programme has been cancelled while there is still water in the machine or during spinning, the following will appear in the display:

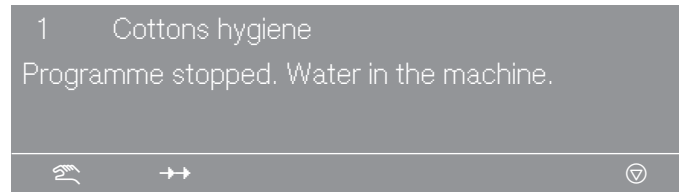

or

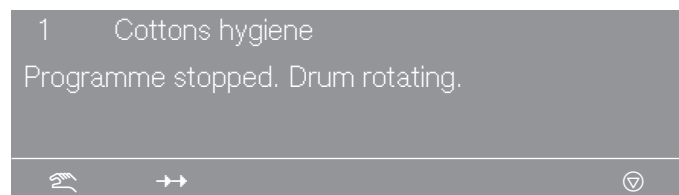

**Tip:** To open the door, press the “Water drainage”  function button or select the “Separate spin” programme and press the “START” button.

### Cancelling a locked programme

It is not possible to stop or cancel a locked programme.

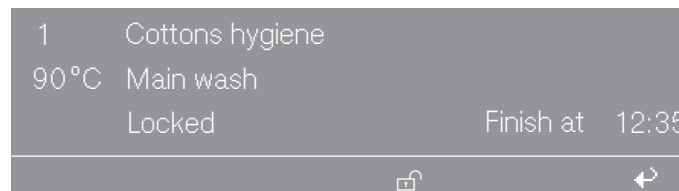

The display will show the locked state if an attempt is made to cancel the programme by pressing the  “Stop/finish” button.

- Press the  “Unlock” function button and enter the password.

When the password is entered, the following appears in the display:

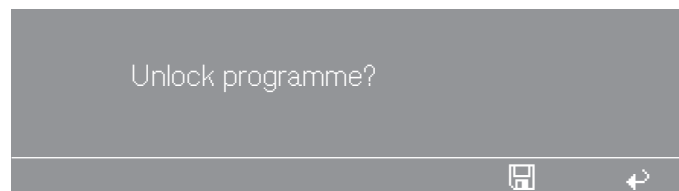

- Press the  “Save” button.

The normal display content will appear and the programme can now be cancelled.

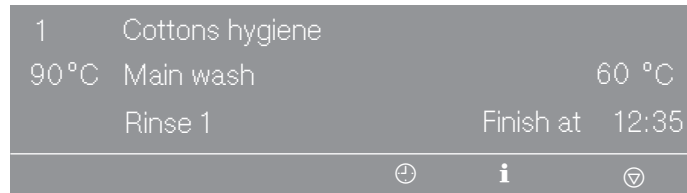

### Skipping a programme

The current programme can be skipped or programme blocks can be repeated.

- Press the ⊖ “Stop/finish” button.

The programme is stopped.

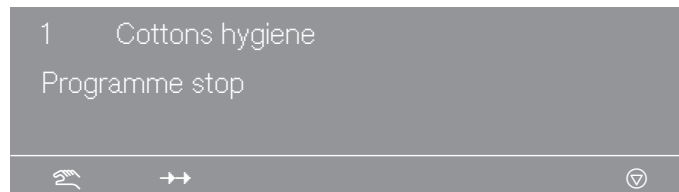

- Press the →→ “Change order” button.

The current area, block or stage appears in the display.

**Tip:** See “Programme structure” for more information.

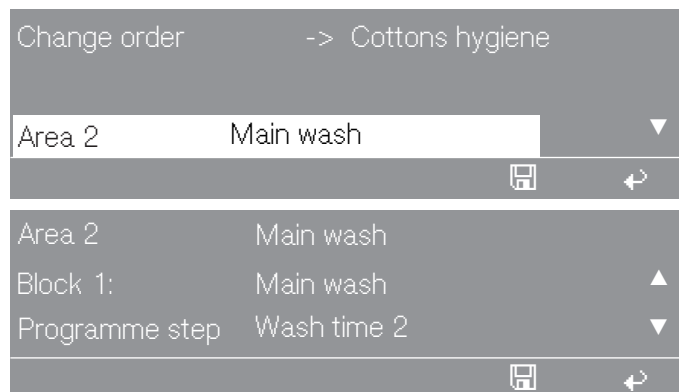

- Rotate the rotary control to highlight Area and press to confirm. Select and confirm areas: 1 Pre-wash, 2 Main wash or 3 Rinse.
- Rotate the rotary control to highlight Block and press to confirm. Select and confirm blocks: 1–10 Pre-wash, 1–10 Main wash or 1–10 Rinse.
- Rotate the rotary control to highlight Stage and press to confirm. Select and confirm the required programme stage.
- Press the ⏪ “Save” button and then “START” to skip the stage.

**Tip:** Press the ⏪ “Back” button to return to programme stop and the Change order will not be performed.

### Liquid dispensing (optional for machines with dispenser compartment)

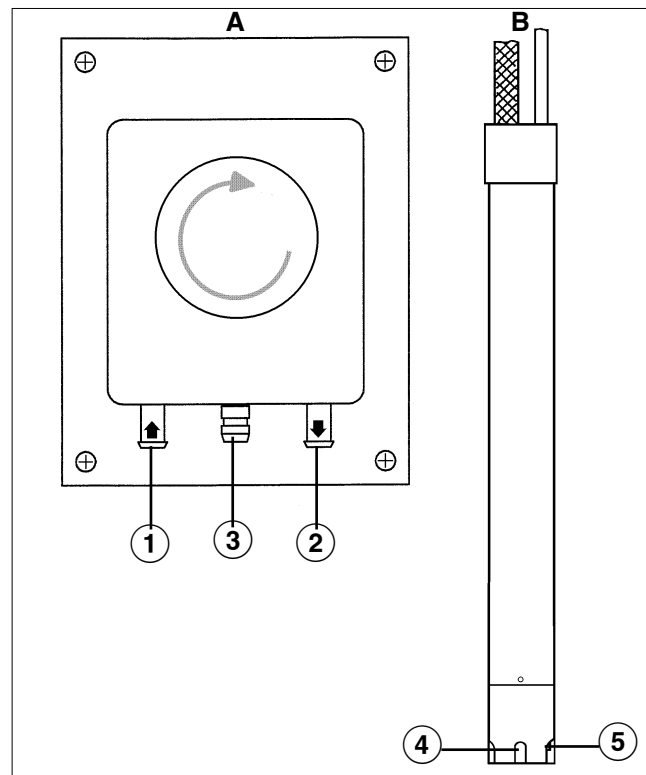

A Dispenser pump

B Siphon

- ① Hose connection (suction side)
- ② Hose connection (pressure side)
- ③ Leakage outlet
- ④ Suction inlet opening
- ⑤ Empty indicator. When the dispenser is empty the pump and the machine switch themselves off.

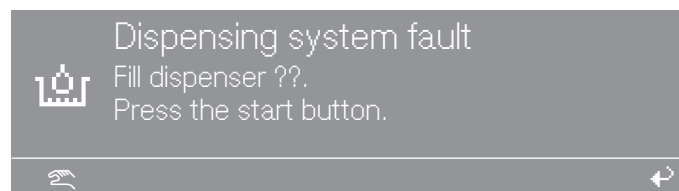

At the same time, the washing machine indicates a lack of liquid detergent. When the dispenser canister has been filled, the programme can be started by pressing the “START” button.

### Deselecting dispensing

Liquid dispensing can be switched off before the programme starts.

1	Whites	90 °C
2	Cottons	60 °C
3	Cottons Intensive	60 °C

- Switch liquid dispensing off manually using the “Dispensing off” function button.
- After the programme has started, no detergent will be dispensed via the dispensing pumps and the following message (for example) will be displayed:

1	Cottons hygiene	10,0 / 10,0 kg	
90 °C	Main wash		
	Rinses	1000 rpm	

### Amount to be dispensed

Please follow the detergent manufacturer's instructions.

#### Risk of injury!

Strong chemical reactions and material damage.

It is particularly important to observe manufacturer's instructions when using a combination of cleaning agents and special application products. Products must only be used for applications approved by the manufacturer to avoid any material damage or the occurrence of strong chemical reactions. Confirmation must be sought from the detergent manufacturer that using the agent in the washing machine will not cause damage.

**Tip:** Correct dosage also depends on the viscosity of the liquid agent. It should therefore be allowed to settle to room temperature before being used.

### Commissioning the dispensing pumps

Before the liquid dispensing pumps can be used the liquid agent must be drawn into the system and the amount to be dispensed set.

### Dispenser calibration

Dispenser calibration is used to measure the throughput of the individual dispensing pumps.

**To go directly to Dispenser calibration when the machine is switched off:**

- Press and hold multifunction button 2 and switch the machine on with I “Power on”.



Options:

- Dispensing pump 1 to 13
- Select a dispensing pump.

When a dispensing pump is selected, the following will appear in the display:

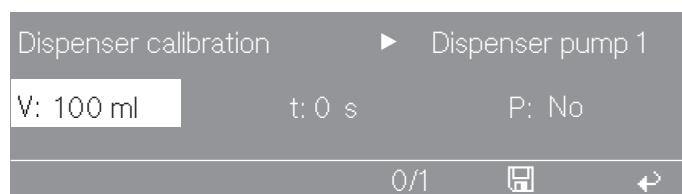

**Tip:** The dispensing quantity can be set from 0 to 9999 ml in 1 ml increments.

- Press the multifunction button 0/1.

The dispensing hose will fill up.

- Stop the process by pressing the 0/1 button.
- Run the hose of the dispensing pump upwards into a measuring vessel.
- Hold the entire measuring vessel above the dispensing pump while doing this.

⚠ Irritant detergents.  
Skin and eye irritation.  
Avoid contact with skin and eyes, wear protective clothing.

- Return to the main menu by pressing the  “Back” button.



- Select a dispensing pump.



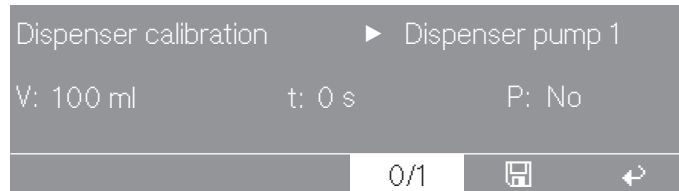

- Press the multifunction button 0/1.

Stop the pump by pressing the 0/1 button, or the pump will stop automatically after 60 seconds.

- Measure the required amount in the measuring vessel.

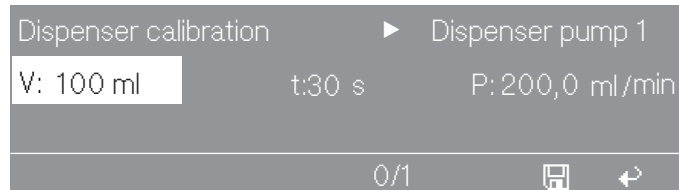

- Enter the amount measured in the V: field.

The throughput P is calculated in ml/min by the controls.

- Press the  "Save" function button.

The measured value is assigned to the pump.

- Reattach the hose.

### Cleaning and maintenance of the dispensing system

Rinse the dispensing system through with hot water every 2 weeks, or before shutting the dispenser pumps down for any length of time, to avoid the system getting clogged up and corroded.

- Also rinse out the siphons with water.
- Put the siphons in a container of warm water (40-50 °C).
- Use dispenser calibration to activate each pump until the dispensing system is rinsed through.
- Check the connection points, hoses, dispensing sockets and washers for leaks.

### Peak-load negotiation

When the peak-load function is activated, the heating is deactivated and the programme stopped.

- Activate the peak-load function.

The following message appears in the display:

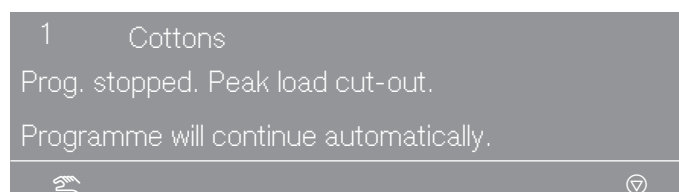

## Optional modules

The programme is resumed automatically when the peak-load function finishes.

### Communication module

The machine can be connected to a PC (personal computer) using the communication module.

The slot for the communication module is located on the back of the machine.

An Editor programme is available for this from your sales and service centre or your Miele dealer.

### Operating data

With the Operating data module, Operating data can be read or deleted via the  “Operating data” button either before programme start or at the end of the programme.

1	Cottons hygiene	90 °C
2	Cottons	60 °C
3	Cottons Intensive	60 °C



- Press the  “Operating data” button.

When the  button is pressed, the following appears in the display:

Operating data module
Total data
Programme data 



You have the following options:

- Total data  
Data from all programmes is collected and added together in Total data.
- Programme data  
Programme data is data which is recorded during a programme.
- Delete data
- Module (delete total data and programme data)
- Total data (only delete total data)
- Programme data (only delete Programme data)

**Tip:** The function can be deselected by pressing the  “Operating data” button again.

If the data storage capacity in the Operating data module is full, a message appears when the “START” button is pressed to inform you that Operating data will be overwritten.

**Tip:** If the  “Back” button is pressed or if the “START” button is not pressed within 30 seconds, the programme will not start and the display appears as before programme start.

### Total data

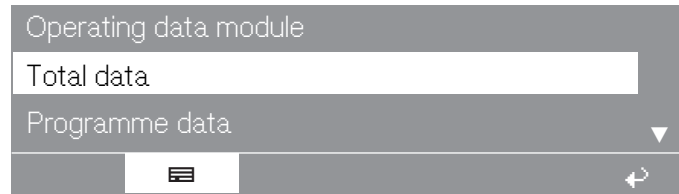

- Select the Total data menu option.

After selecting Total data (for example), the following appears in the display:

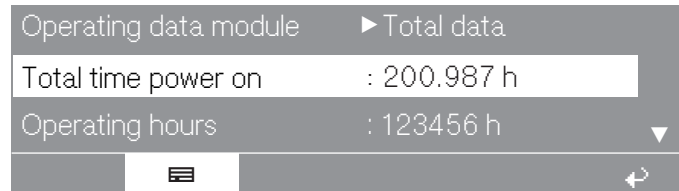

#### Further options:

- Total time power on: 200,987 h
- Operating hours: 123,456 h
- Duration heating active: 73,456 h
- Duration drive motor active: 93,456 h
- Programme starts: 23,456
- Programme stops: 567
- Programme cancellations: 67
- Water volume: 1,234,567 l
- Load: 1,234,567 kg
- Liquid agent: 2345 l
- Energy: 12,345,678 kWh

### Programme data

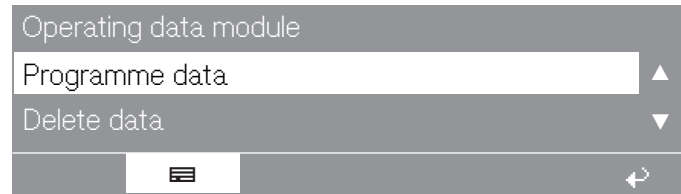

- Select the Programme data menu option.

After selecting Programme data (for example), the following appears in the display:

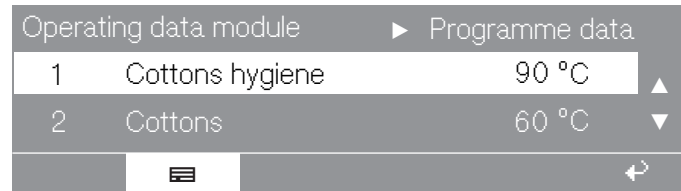

- Select the relevant programme from the programme list and confirm your selection by pressing the rotary control.

A list of all programme starts of “Programme ► 1” will then appear with the date and start time.



- Select the programme start you want from the list of all “Programme ► 1” programme starts and confirm your selection by pressing the rotary control.



Further options:

- Town: Lehrte
- Serial number: 12345678
- Machine type PW 6321
- Load: 13 kg
- + button: pressed
- Starch stop button: pressed
- Without spin button: not pressed
- Programme start: 11:30
- Programme finished: 12:05
- Total operating time: 0 h 35 min

## Optional modules

---

- Electrical energy: 12.5 kWh
- Gas energy: 0 kWh
- Steam energy: 0 kWh
- Total volume of water: 140 l
- Max. water temperature: 95 °C
- Max. drain temperature: 45 °C
- Programme change: 2 (after selecting and pressing the rotary control, only the last 3 stops and 3 starts are displayed.)
- Programme fault: none (only the last 3 faults are saved.)
- Area 1: Pre-wash (after selecting and pressing the rotary control, the area and the block can both be changed.)
- Block 1: Pre-wash
- Operating time: 6 min
- Water volume: 20 l
- Dispensing phase 1: amount ml (after selecting and pressing the rotary control, the 6 dispensations are displayed.)
- Max. temperature: 12 °C
- Holding time: 6 min
- Dispensing phase 2: No

## Delete data

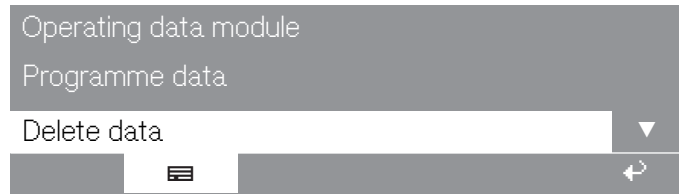

- Select the Delete data menu option.

After selecting Delete data, the following appears in the display:

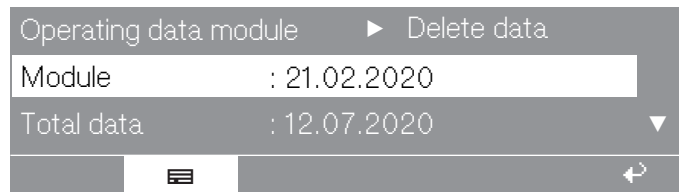

With the Module menu option, the Total data and the Programme data will be deleted from the Operating data.  
 With the Total data menu option, only the Total data will be deleted from the Operating data.  
 With the Programme data menu option, only the Programme data will be deleted from the Operating data.

- Rotate the rotary control to select one of the menu options and press the rotary control to confirm the selection.

A prompt to enter a password then appears.

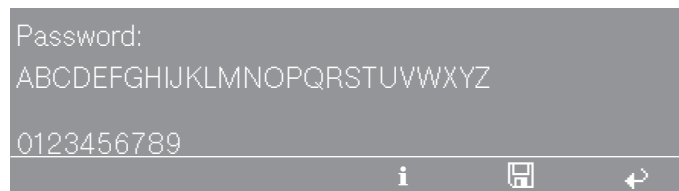

- Enter the password or insert the card for supervisor level.

The menu option is accessed and an additional security question appears.

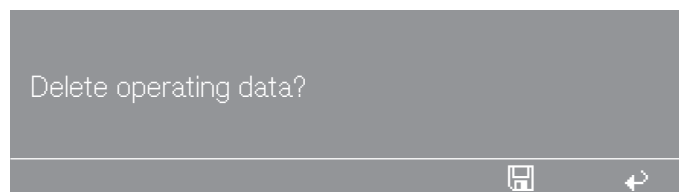

- Press the  "Save" button.

The data is deleted.

## Optional modules

### Weighing system/weighing plinth

If the machine is equipped with a weighing plinth, the load weight is displayed in 0.2 kg increments during loading. The maximum load weight for the selected programme is displayed beside it.

### Resetting the load display to zero

Do not place any items on the machine. Do not lean against the machine.

This can influence the result of the measurement.

If the load display does not show “0.0” with an empty drum, set the display to 0 using the **→←** button.

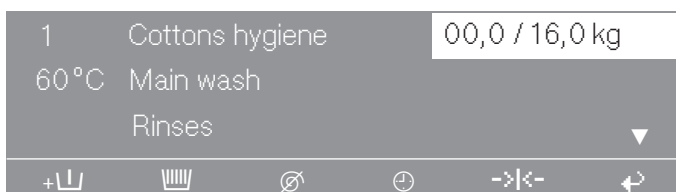

- If after resetting to 0 (taring), you discover an overlooked item in the drum, the following will appear in the display:

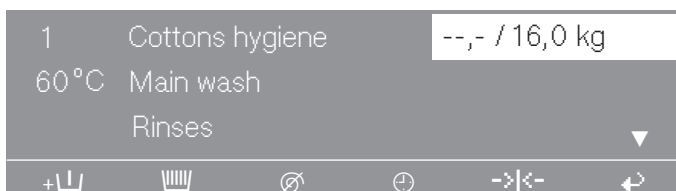

- Reset the display to 0 using the **→←** button.

**Tip:** If the machine is overloaded, for example when laundry is wet, it will operate in accordance with the nominal load after the programme starts. This value is also saved in the operating data module.

At the end of the programme when the drum has stopped rotating, the residual moisture in the laundry is shown in the display.

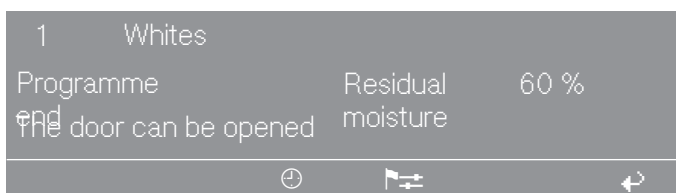



### The drum door cannot be opened

- Press against the door handle, turn the machine off and on and then pull the door handle again.

### The safety catch of the door handle is disengaged

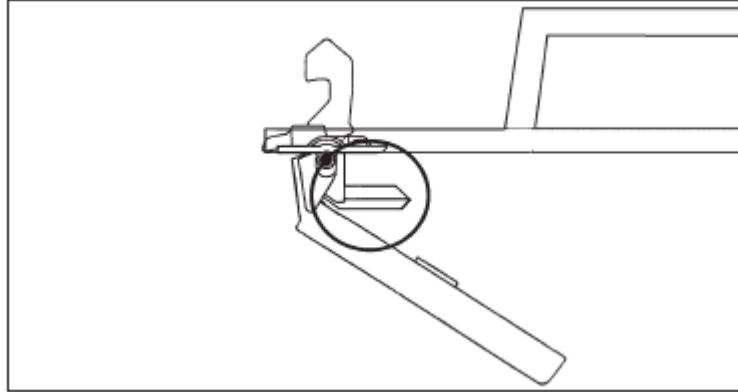

The door handle has stopped working. It is no longer possible to open or close the drum door.

The disengagement of the safety catch is intended to prevent damage to the door handle and lock in case of forced opening of the drum door.

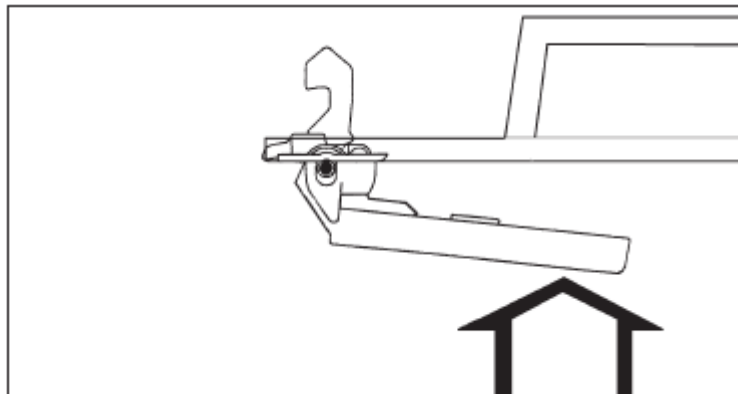

- Press firmly against the door handle until the safety catch audibly engages.

The drum door can be opened again (provided there is no water in the machine) or closed.

### Power failure during the wash cycle; opening the door in an emergency

**In the event of a brief power failure:**

The programme stops in the last position reached and the following message appears in the display once the power supply has been re-stored:

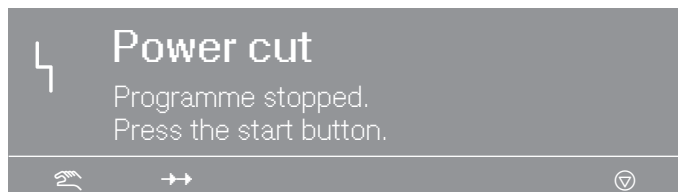

- Press the “START” button and the programme will continue.

### In the event of a longer power failure

- Switch the machine off.
- Switch the machine off with the (on-site) power switch.
- Close the on-site shut-off valves for water or steam.

To remove the laundry, first open the drain valve manually and then manually unlock the drum door.

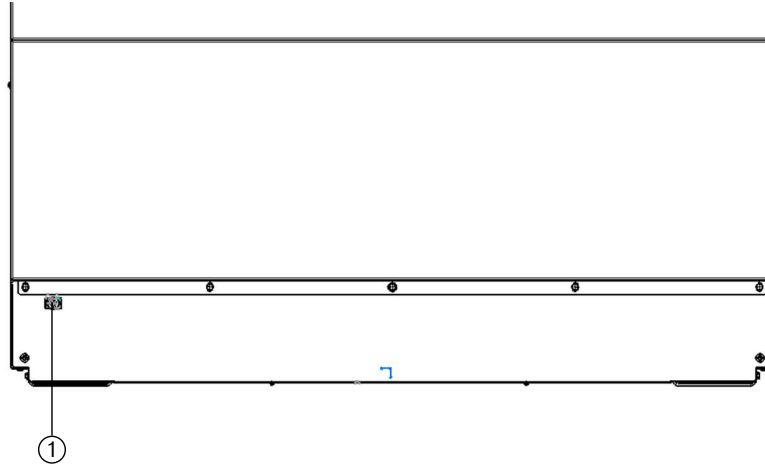

- Insert a screwdriver through the eye ① on the front of the machine.
- Open the drain valve by pulling the eye.
- Keep pressing the eye until the suds have drained away completely. The suds will drain away.

The emergency drain closes automatically when the screwdriver is removed from the slot.

- Then retighten the bleed screw and check for leaks (open the water shut-off valve).



- First insert the screwdriver into the opening next to the door lock, press it in and hold it. Press against the door handle with your right hand and then pull the door handle to open the drum door. Never use force to open the drum door!

- Remove the laundry.

### **Possible reasons for increased levels of foaming**

#### **Detergent type**

- Only use detergent formulated for use in commercial washing machines. Domestic laundry detergent is not suitable.

#### **Too much detergent**

- Dispense detergent following the instructions on the packaging and in accordance with local water hardness levels.

#### **Detergent creates too much foam**

- Use a lower foaming detergent or contact your detergent application specialist.

#### **Very soft water**

- In areas with water hardness level 1, add less detergent in accordance with the detergent manufacturer's instructions.

#### **Dirtiness of the laundry**

- For lightly soiled laundry dispense less detergent in accordance with the detergent manufacturer's instructions.

#### **Residues, e.g. cleaning agent left on laundry**

- Run an additional pre-wash without detergent and without selecting a temperature. Laundry which has been pre-treated before washing must be thoroughly rinsed before running a wash programme.

#### **Small loads**

- Reduce the amount of detergent dispensed according to the size of the load.

#### **Drum speed too high during the wash (Profitronic controls)**

- Reduce the drum speed and wash rhythm.

#### **Large items stretched during spinning**

Large items (e.g. tablecloths) can get stretched during spinning. This can mostly be prevented by reprogramming.

Please contact the Customer Service Department.

### Service interval and DGUV display

If the following message appears in the machine display after “Power on”, either a service or the annual DGUV check must be carried out.

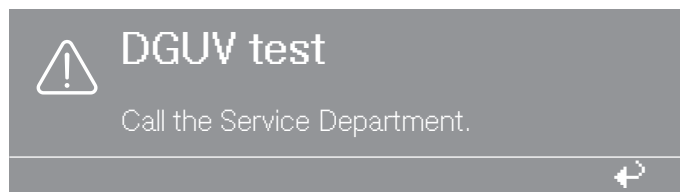
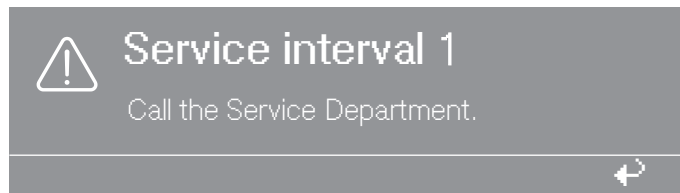

The display will go out after 5 seconds.

 Repairs to electrical or steam heated machines must only be undertaken by a suitably qualified specialist. Repairs by unqualified persons can cause considerable danger to users.

- Malfunctions occurring before or after the start of a programme will be shown in the display.



The display remains dark. There is no power to the washing machine.

- Check the plugs, power switch and (on-site) fuses.

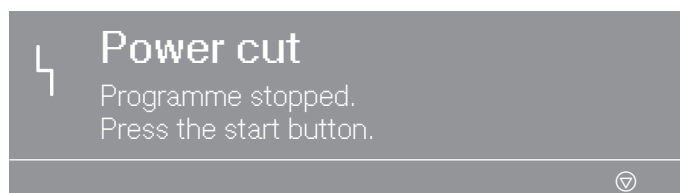

- Once the power has been restored, press the “START” button.

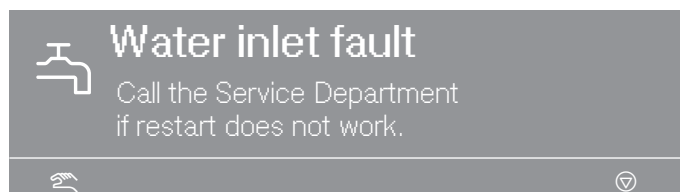

**Tip:** This fault message can also mean: the winding protection of the drive motor has been triggered.

- Allow the motor to cool down.





- Check the stopcock and press the “START” button.

 **Door lock fault**  
Call the Service Department  
if restart does not work.

- Press firmly against the door handle until the door lock audibly engages and press the “START” button.

 **Heating system fault**  
Programme stopped. Press start.  
Programme will continue without heat.



 

- Press the “START” button to continue the programme without heating.

**Tip:** Disinfection programmes will be cancelled if this fault message appears.



- Contact the Customer Service Department.

 **Drive motor fault**  
Programme stopped. Press start.  
Motor overheating.

- Allow the motor to cool down.



 **Imbalance fault**  
Call the Service Department  
if restart does not work.

Too large an imbalance. The imbalance switch has been triggered.

- Switch the machine off and back on again and press the “START” button.



 **Drain valve fault**  
Call the Service Department  
if restart does not work.

- Check the on-site drainage system and press the “START” button.

A defective drain valve must only be repaired by the Customer Service Department.

 **Dispensing system fault**  
Fill dispenser ???. Press the start button.

- Change the dispenser canister.

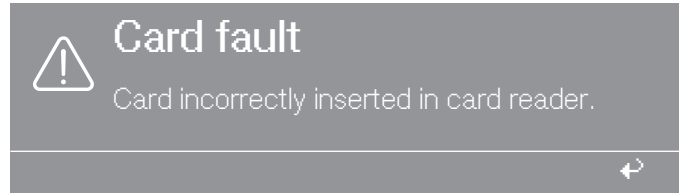

- Insert the card into the card reader correctly.

## Problem solving guide

---

### Customer Service Department

In the event of a malfunction, contact the Miele Customer Service Department.

When contacting the Customer Service Department, please quote the model, serial number (SN) and material number (mat. no.) of your machine. This information can be found on the data plate. The data plate is visible above the door ring when the drum door is open, or on the back of the machine at the top:

<b>Model</b>			
<b>SN:</b>	/ 0 0 0 0 0 0 0 0 0 0		
<b>Art.-Nr.</b>		<b>Mat -Nr.</b>	
<b>IBN</b>			

Please also pass on the fault message appearing in the machine display to the Customer Service Department.

**Use only original Miele spare parts.** The Miele Customer Service Department will also require the model, serial number (SN) and material number (mat. no.) when ordering.



- Carry out cleaning and maintenance of the machine after use if possible.

Do not use a pressure washer or hose to clean the machine.

- Clean the **machine casing, control panel and plastic parts** with a mild non-abrasive cleaning agent or with a damp cloth only. Wipe dry with a soft cloth.

Scouring agents will scratch the surface.

- Clean stainless steel casing with a proprietary stainless steel cleaner.
- Remove any deposits from the door seal with a damp cloth.

Penetration of cleaning agents into electrical components.

- When disinfecting the surfaces, use a damp cloth only to clean the front and around the door lock. Do not spray any liquids.
- Clean stainless steel casing with a proprietary stainless steel cleaner.
- Remove any deposits from the door seal with a damp cloth.

**Tip:** Heavy deposits of dust around the fan housing should be removed with a vacuum cleaner. The fan housing is located on the back of the machine.

### Build-up of rust

The drum is manufactured from rust-free stainless steel. Water or foreign objects containing ferrous substances (e.g. paper clips, metal buttons or metal swarf) which are placed in the machine with the laundry can cause a build-up of rust in the drum. Clean the drum regularly in this case and if rust occurs, remove it immediately with a proprietary stainless steel care product. Check the door seals for ferrous residues and clean thoroughly as described above. This must be carried out regularly.

### **Cleaning the detergent drawer, detergent compartments and siphons**

- Clean the detergent drawer and the detergent compartments thoroughly with hot water as required to remove detergent residues and incrustations.
- If the machine is not going to be used for a long time, leave the flap of the detergent drawer open.
- Also clean the siphons in the compartments for cleaning agents.

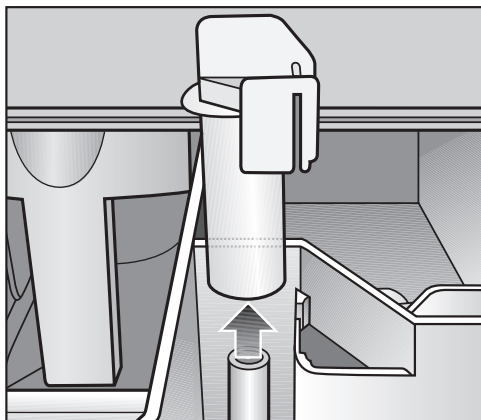

- Remove the siphon. Clean the siphon with hot water and reinsert it.

### Cleaning the drip channel and siphon

- Open the flap on the detergent drawer to an angle of 45° and lift out the flap of the detergent drawer on the right side.

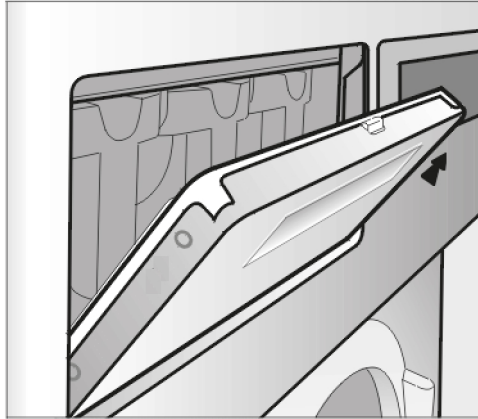

If the drip channel and associated drain connection are blocked, clean them.

- Check the vapour extraction grille on the rear of the machine for contamination from time to time and clean when necessary.

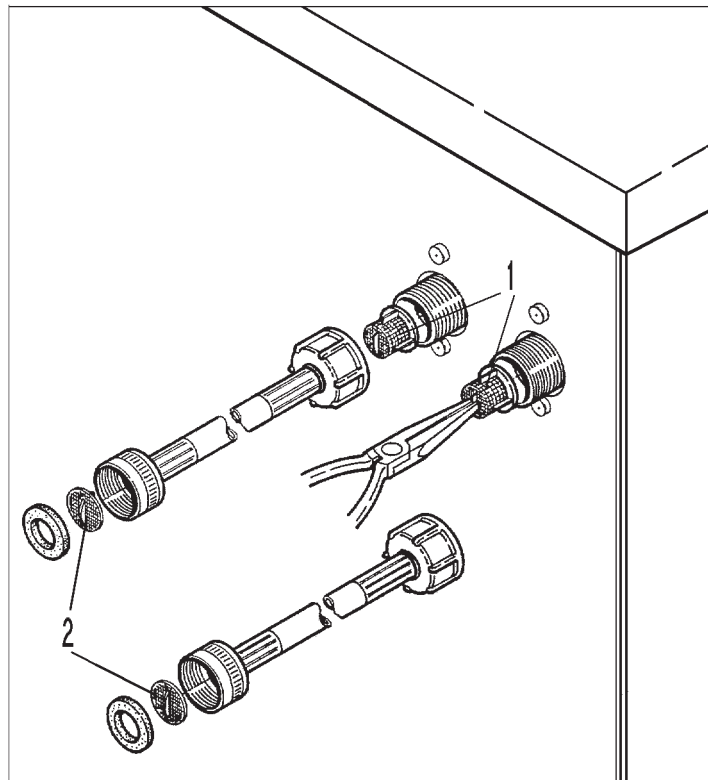

- The filters in the water intake valves (1) and the inlet hoses (2) must be checked for contamination from time to time and cleaned as necessary.

### Drum shaft bearings

Once the service interval has been reached, the following message appears in the display:

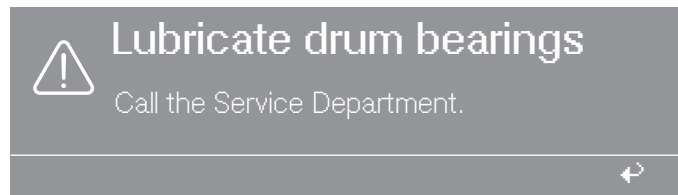

This message is removed by pressing the  button. It appears after switching on the machine until the service technician has performed this work.

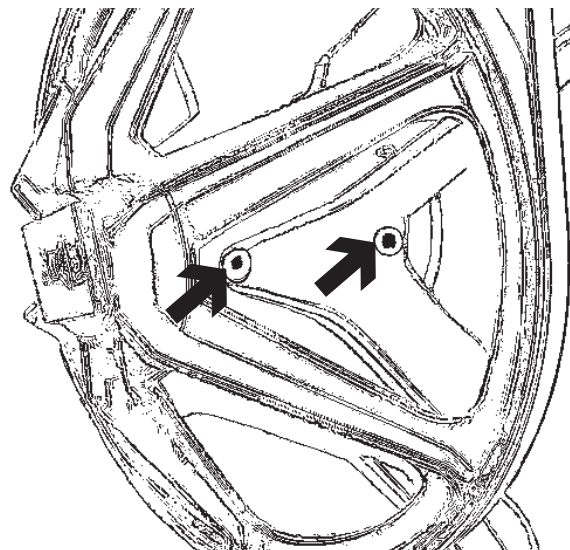
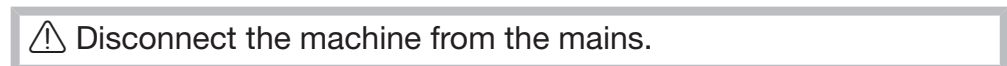

Use grease nipples to lubricate the drum shaft bearings with Arcanol L 100 grease after approx. 1000 operating hours.

### Downtimes

If the machine is to be shut down for an extended period (4 weeks or more), grease the drum bearings in accordance with the maintenance instructions before shutting down the machine and rotate the drum a few revolutions. Repeat this drum rotation every 4 weeks to prevent bearing damage.

# Meaning of the symbols on the data plate

<b>Model</b>	①				
<b>SN:</b>	②				
<b>Art.-Nr.</b>	③				
<b>Mat.-Nr.</b>	④				
⊙	⑤		⊙		
⊙			⊙		
⊙			⊙		
⊙			⊙		
	⑥				
	⑦				
	∅ → →	⑨	$Q_n$ (Hi) ②②		
		⑩			
	Vol./G	⑪			
	E kin	⑫			
	0 → → → 1/min	⑬			
	→ → → 0 1/min				
				IP X4	
				⑬	

<b>Model</b>	
<b>SN:</b>	/ 0 0 0 0 0 0 0 0
<b>Art.-Nr.</b>	Mat.-Nr.
<b>IBN</b>	

- ① Model
- ② Serial number
- ③ Item number
- ④ Material number
- ⑤ Voltage/frequency
- ⑥ Control fuse
- ⑦ Drive motor
- ⑧ Drum data
- ⑨ Drum diameter/drum depth
- ⑩ Spin speed
- ⑪ Drum volume/laundry dry weight
- ⑫ Kinetic energy
- ⑬ Ramp-up time
- ⑭ Braking time
- ⑮ Heating
- ⑯ Designation/year of construction
- ⑰ Commissioning date
- ⑱ Electric heating
- ⑲ Fuse (on site)
- ⑳ Indirect steam heating
- ㉑ Direct steam heating
- ㉒ Gas heating
- ㉓ Field for certification marks/identifiers

## Sound emissions

A-weighted noise power level

	Washing	Spinning
PW 6241	60 dB	82 dB
PW 6321	60 dB	80 dB

measured according to EN ISO 9614-2

## Installation

The washing machine must be installed by a Miele service technician or by an authorised dealer.

⚠ This washing machine is only intended for items of laundry that have not been proofed with dangerous or inflammable substances.

Remove packaging carefully with a suitable tool.

The washing machine must be level and secured to the floor (see the installation plan provided).

To avoid the risk of frost damage, the washing machine must not be located in rooms which may be subject to very low temperatures.

Do not place the washing machine on carpeted floors if the carpet may block the ventilation openings on the bottom of the casing.

### Transit bars

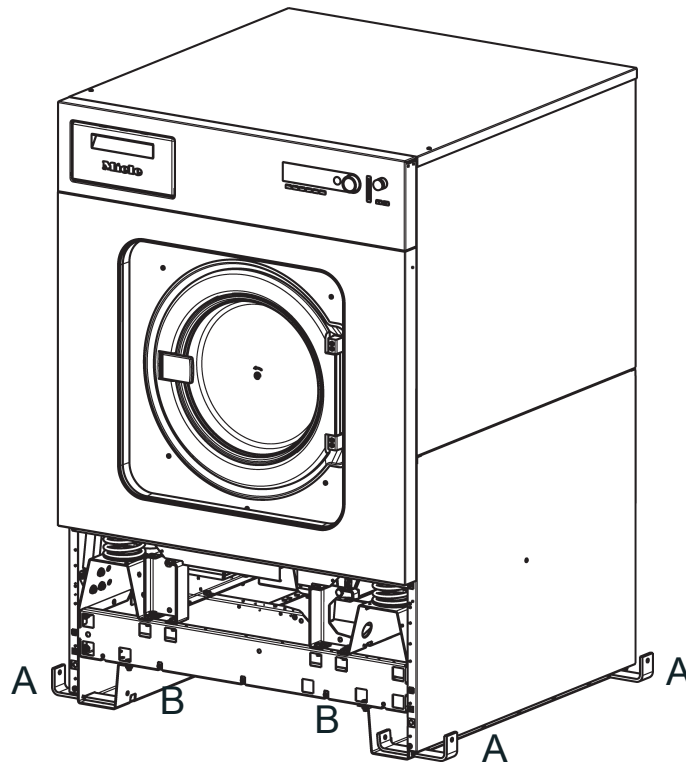

The fastening brackets “A” on the sides, 2 each on the left and right, for the transport crate are each fastened with one hexagon head screw and can be removed.

The transit bars “B”, 2 x at the front and 2 x at the rear, are each secured with 3 hexagon head screws and must only be removed at the installation site before the washing machine is commissioned.

To do this, the machine’s service panel and rear panel need to be removed. Unscrew the hexagon head screws at the bottom of the front service panel and remove the panel. Unscrew the hexagon head screws on the rear panel and remove the panel.

The front plinth panel is screwed to the rear panel and the rear plinth panel is located under the machine cover and they are both to be mounted after installation. The screws for this are in the accessory pack.

Keep the transit bars in a safe place. They need to be reinstalled should the machine ever need to be moved again.

Transport the machine on a pallet truck inside the room.

Do not move the machine until all casing parts have been installed.

## Water connection

### Water connections

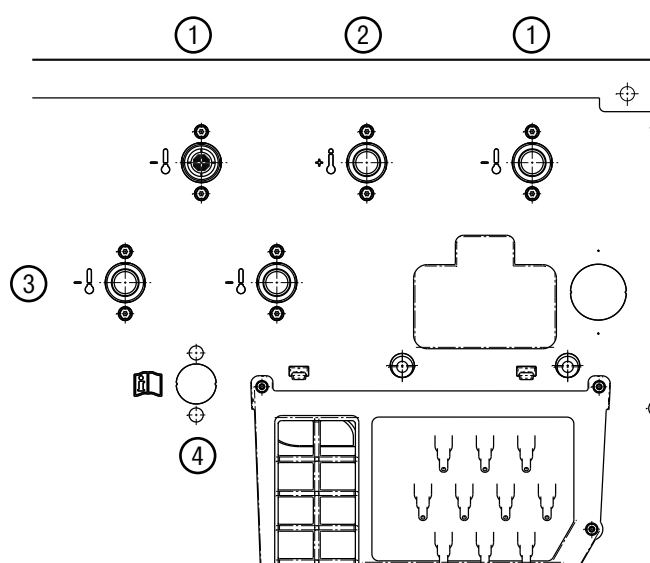

- ① Cold water
- ② Hot water
- ③ Hard water/cold water
- ④ Cold water for liquid dispensing

The connection to the supply line established in accordance with DIN 1988 must be made via a water shut-off valve. This installation may only be carried out by an authorised installation technician in accordance with local and national regulations.

- DVGW (Germany)
- ÖVGW (Austria)
- SVGW (Switzerland)
- Regulations set out by the responsible water supplier or regional building regulations.

## Installation

---

### Connection to the water inlet/drainage

See the installation plan provided.

Water pressure (flow pressure) of a minimum of 100 kPa (1 bar)/maximum of 1000 kPa (10 bar) is required to guarantee problem-free programme operation.

The machine must be connected to the water supply using the inlet hoses provided.

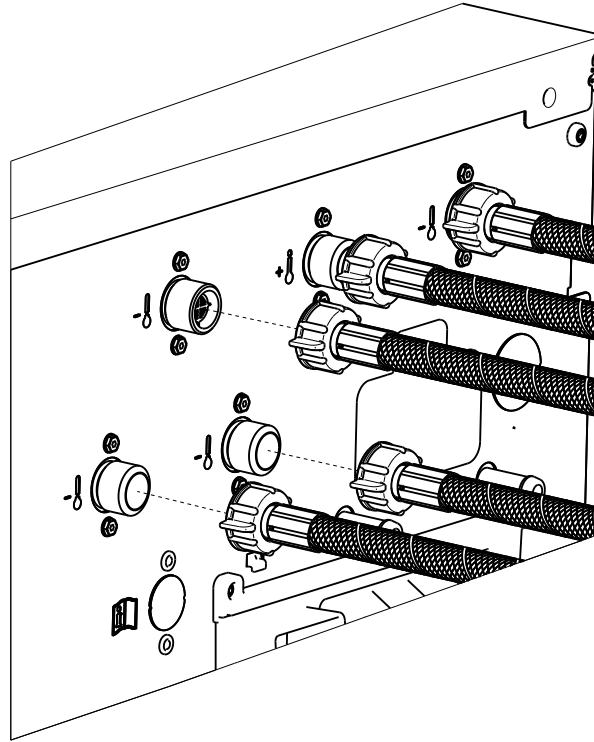

Before attaching the inlet hoses to the machine, the filters and seals included in the accessory pack must be inserted.

Hoses must be replaced with hoses tested for a burst pressure of at least 7000 kPa (70 bar) and for water temperatures of a minimum of 90 °C. This also applies to the associated connection fittings. Miele original spare parts fulfil these requirements.

The hot water supply must not exceed a maximum temperature of 70 °C.

### Connection to the cold water supply

- See the installation plan provided.

### Use of non-return valves

In Germany, the machine must be connected to the water supply using the non-return valve provided.

According to national regulations for drinking water quality, with effect from 21 March 2021, a non-return valve to prevent backsiphoning must be installed between the stopcock and the water inlet hose during commissioning on all machines in Germany. The non-return valve prevents water from the water inlet hose from flowing back into the on-site drinking water supply.



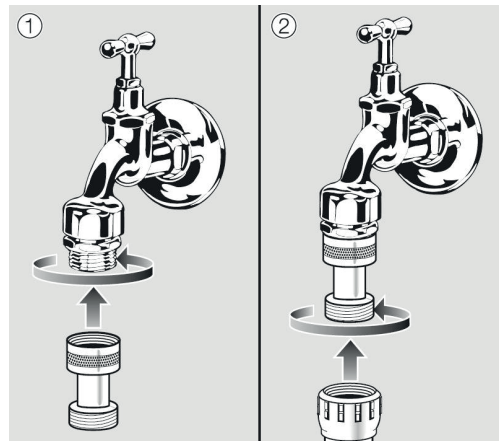

- Screw the non-return valve onto the stopcock.
- Screw the water inlet hose onto the thread of the non-return valve.

## Regulations for Austria

Only pipes which comply with § 12 Section 1 of the 1960 Regulation on Execution of the Water Supply Act may be used to connect the machine with the installation location interior.

The use of rubber or plastic tubing as pressure connection piping between the installation location interior and the machine is only permitted if:

- in conjunction with connection fittings, it can withstand a minimum permanent pressure of 1500 kPa (15 bar),
- it is satisfactorily inspected during commissioning and
- after each use of the machine the water supply is reliably cut off before the rubber and plastic piping and put out of service or cut off from the location interior.

## Dispensing agent connection to the mixer compartment

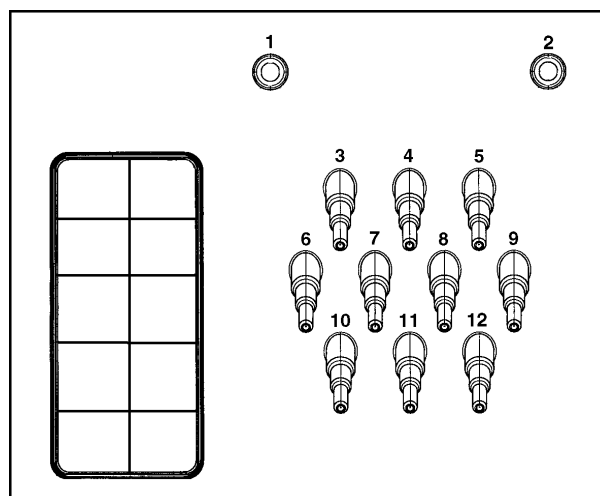

Connections **1** and **2** are provided for viscous agents. These connectors are sealed and need to be drilled open using an 8 mm drill bit.

## Installation

---

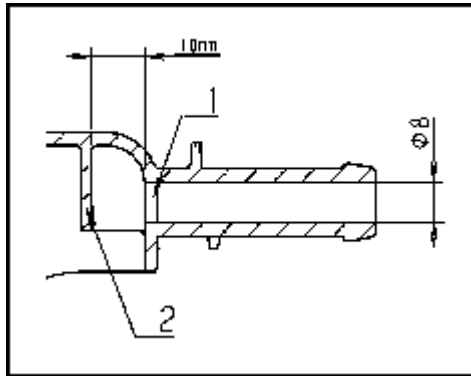

Care must be taken to drill through the first panel (1) only, as there is a deflecting wall (2) 10 mm behind it.

If the drilled out connections are no longer required, they must be resealed.

Connections **3** to **12** are provided for liquid dispensing. These connectors are sealed and must be cut to the diameter of the hose with a small saw. If opened connectors are no longer required, they must be resealed.

## Electrical connection

The electrical connection must only be carried out by a suitably qualified electrician in accordance with local and national regulations such as BS 7671 in the UK.

Connection should be made with a suitably rated plug and socket.

When installing a residual current device (RCD), it must be **Type B**.

The electrical components of the machine PW 6241, PW 6321 comply with EN 60335-1, EN 60335-2-7.

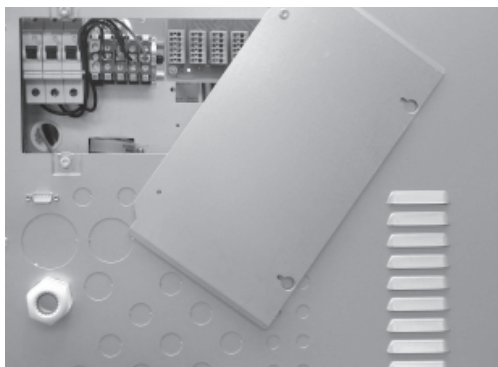

Connection terminals are located behind a cover.

The machine is supplied ex-works for 3N AC 50–60 Hz. The voltage is stated on the data plate.

### Versions:

3 N AC 380–415 V 50–60 Hz

3 AC 220–240 V 50–60 Hz

For hard-wired machines, an all-pole means of deactivation must be provided on site. Switches with a minimum contact gap greater than 3 mm are suitable disconnectors. These include circuit breakers, fuses and contactors (VDE 0660).

The plug connector or disconnector must be easily accessible at all times.

If the machine is disconnected from the power supply, the disconnector must be lockable or the point of disconnection must be monitored at all times.

## Equipotential bonding

An equipotential bond with good contact connection must always be provided in accordance with all national and local regulations.

The electric heating is set ex-works to 24 kW (PW 6241), 30 kW (PW 6321).

The minimum liquor level to activate the heater is 110 mm water column.

The motor is protected against overload by winding protection.

Please refer to the wiring diagram and installation plan provided. These plans are important for the electrical connection.

## Connecting the dispensing pumps

Connection terminals for 4 time-controlled dispensing pumps, which can be operated without a multifunction module, are located behind the cover adjacent to the electrical connection. See enclosed wiring diagram.

## Steam connection

The steam connection may only be carried out by a registered installation technician. See the installation plan and installation instructions provided.

The steam valve and the condensate separator are available from Miele dealers or the Miele Customer Service Department.

Once the machine has been successfully installed and connected, replace all the casing parts that were removed.

 Risk of electric shock and injury from live or rotating machine parts.

If the washing machine's casing is not fully assembled, it is possible to come into contact with live or rotating machine parts.

Once the washing machine has been installed, completely reassemble all the casing parts that were removed.

## 1. Preparing the laundry

Only machine wash items which have a wash care label stating that they are suitable for machine washing or for wet cleaning.

- Empty all pockets.



## 2. Switching on the machine and loading the laundry

- Switch on the washing machine with the **I** button.
- Pull the door handle to open the drum door.
- Unfold the laundry and load loosely into the drum. Mixing both large and small items gives better wash results and also helps to distribute the load evenly during spinning.
- Close the drum door by pressing it until the pre-latch engages.

## 3. Adding detergent

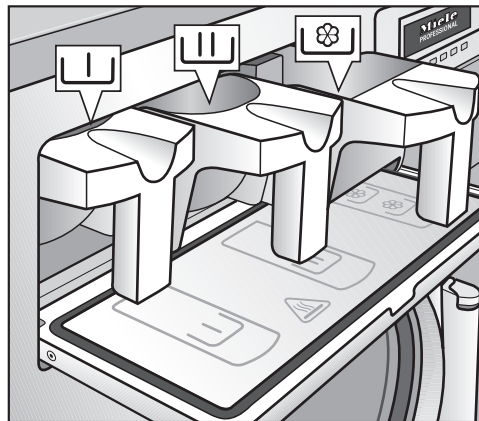
There are three separate drawers for adding detergent.



- Add powder detergent to the  drawer for the main wash.
- Add detergent for the pre-wash to the  drawer if necessary.
- Add fabric conditioner to the front  drawer if necessary.

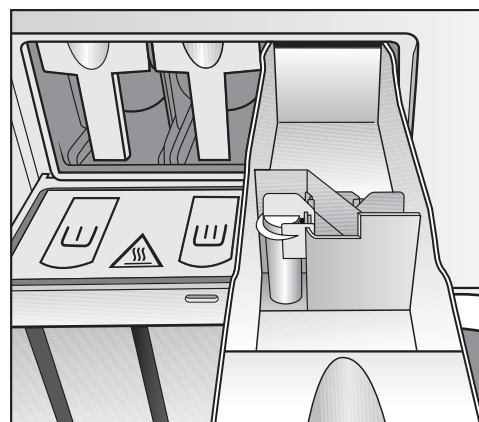

Liquid bleaching agents must only be dispensed through the designated  drawer.

### 4. Select a programme by rotating the rotary control

### 5. Press the “START” button to start the selected wash programme

If the message “Door lock error” appears, proceed as follows:

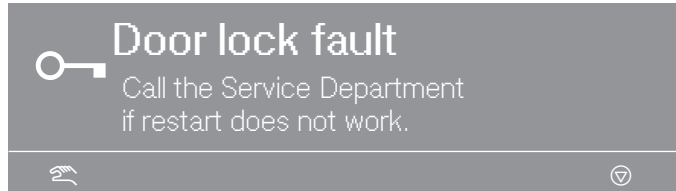

- Press firmly against the door handle until the door lock audibly engages.
- Press the “START” button.

### 6. The end of the programme is indicated in the display

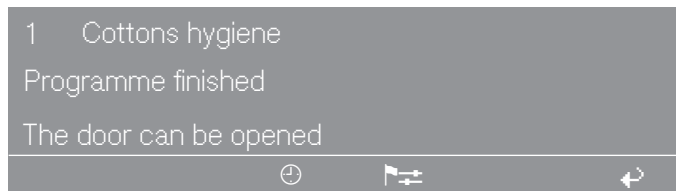

- Pull the door handle to open the drum door at the end of the programme.
- Remove the laundry.

### 7. If no further wash programmes are planned:

- Leave the drum door open.
- Switch off the machine with the 0 “Power off” button.



## United Kingdom

Miele Co. Ltd., Fairacres, Marcham Road  
Abingdon, Oxon, OX14 1TW  
Professional Sales, Tel: 0845 365 6608  
E-mail: professional@miele.co.uk  
Internet: www.miele.co.uk/professional

## Australia

Miele Australia Pty. Ltd.  
ACN 005 635 398, ABN 96 005 635 398  
Level 4, 141 Camberwell Road, Hawthorn East, VIC 3123  
Tel: 1300 731 411  
Internet: www.miele.com.au/professional  
E-mail: sales@miele-professional.com.au

## China Mainland

Miele Electrical Appliances Co., Ltd.  
1-3 Floor, No. 82 Shi Men Yi Road  
Jing' an District, 200040 Shanghai, PRC  
Tel: +86 21 6157 3500, Fax: +86 21 6157 3511  
E-mail: info@miele.cn, Internet: www.miele.cn

## Hong Kong, China

Miele (Hong Kong) Ltd.  
41/F - 4101, Manhattan Place  
23 Wang Tai Road, Kowloon Bay, Hong Kong  
Tel: (852) 2610 1025, Fax: (852) 3579 1404  
Email: customerservices@miele.com.hk  
Website: www.miele.hk

## India

Miele India Pvt. Ltd.  
1st Floor, Copia Corporate Suites,  
Commercial Plot 9, Mathura Road, Jasola,  
New Delhi - 110025  
E-mail: customercare@miele.in, Website: www.miele.in

## Ireland

Miele Ireland Ltd.  
2024 Bianconi Ave., Citywest Business Campus, Dublin 24  
Tel: (01) 461 07 10, Fax: (01) 461 07 97  
E-Mail: info@miele.ie, Internet: www.miele.ie

## Malaysia

Miele Sdn Bhd  
Suite 12-2, Level 12  
Menara Sapura Kencana Petroleum  
Solaris Dutamas No. 1, Jalan Dutamas 1  
50480 Kuala Lumpur, Malaysia  
Phone: +603-6209-0288  
Fax: +603-6205-3768

## New Zealand

Miele New Zealand Limited  
IRD 98 463 631  
8 College Hill  
Freemans Bay, Auckland 1011, NZ  
Tel: 0800 464 353  
Internet: www.miele.com.au/professional  
E-mail: sales@miele-professional.com.au

## Singapore

Miele Pte. Ltd.  
29 Media Circle, #11-04 ALICE@Mediapolis  
Singapore 138565  
Tel: +65 6735 1191, Fax: +65 6735 1161  
E-Mail: info@miele.com.sg  
Internet: www.miele.sg

## South Africa

Miele (Pty) Ltd  
63 Peter Place, Bryanston 2194  
P.O. Box 69434, Bryanston 2021  
Tel: (011) 875 9000, Fax: (011) 875 9035  
E-mail: info@miele.co.za  
Internet: www.miele.co.za

## United Arab Emirates

Miele Appliances Ltd.  
Showroom 1, Eiffel 1 Building  
Sheikh Zayed Road, Umm Al Sheif  
P.O. Box 114782 - Dubai  
Tel. +971 4 3044 999, Fax. +971 4 3418 852  
800-MIELE (64353)  
E-Mail: info@miele.ae, Website: www.miele.ae



Manufacturer: Miele & Cie. KG  
Carl-Miele-Straße 29, 33332 Gütersloh, Germany